





ASSEMBLY INSTRUCTION

MODEL : SHAPE PARSON

Important note: - Place all wooden part on a clean and smooth surface such as rug or carpet to avoid the part from being scratch.
 - Please follow the assembly instruction step by step.
 - Do not tighten all screw until the chair is fully set-up.

Hardware List (2 pcs)

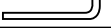
No	DESCRIPTION	QTY.
A	JCBC M6 x 80mm 	8 pcs
B	JCBC M6 x 50mm 	8 pcs
C	JCBC M6 x 35mm 	2 pcs
D	Spring Washer 	18 pcs
E	Flat Washer 	18 pcs
F	Allen Key 	1 pc

Part List (2 pcs)

No	DESCRIPTION	QTY.
1	Chair Back	2 pcs
2	Front Leg	4 pcs
3	Chair Seat	2 pcs

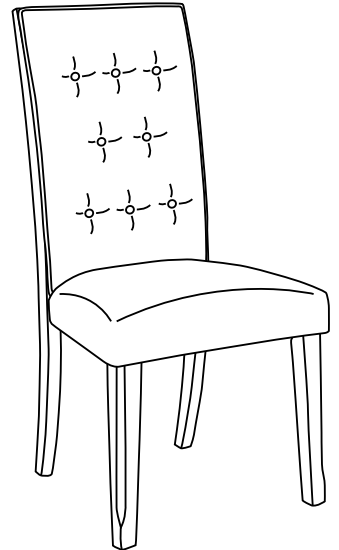
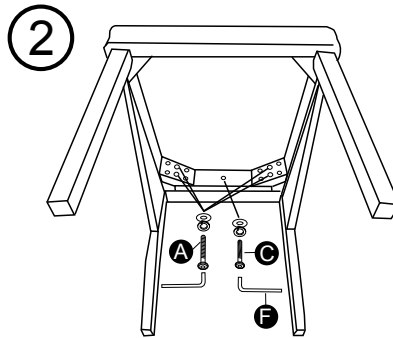
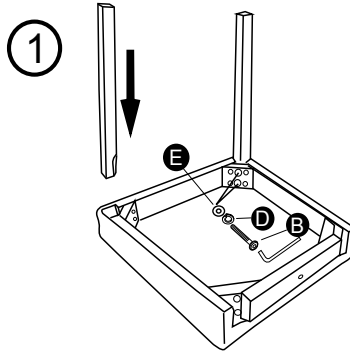







ASSEMBLY INSTRUCTION

MODEL : SHAPE PARSON

Important note: - Place all wooden part on a clean and smooth surface such as rug or carpet to avoid the part from being scratch.
 - Please follow the assembly instruction step by step.
 - Do not tighten all screw until the chair is fully set-up.

Hardware List (2 pcs)

No	DESCRIPTION	QTY.
A	JCBC M6 x 80mm 	8 pcs
B	JCBC M6 x 50mm 	8 pcs
C	JCBC M6 x 35mm 	2 pcs
D	Spring Washer 	18 pcs
E	Flat Washer 	18 pcs
F	Allen Key 	1 pc

Part List (2 pcs)

No	DESCRIPTION	QTY.
1	Chair Back	2 pcs
2	Front Leg	4 pcs
3	Chair Seat	2 pcs

