

# SW 8021 - Q / K

## WARNING!!

- Remove hardware from box and sort by size.
- Please check to see that hardware and parts are present prior start of assembly.
- Please follow attached instruction in the same sequence numbered to ensure fast and easy assembly.
- Do not use this bed if any part is broken, torn or missing.
- The assembly of this product requires two people.
- Do not use any power tools as this may damage the frame and will invalidate any claim.

Attach the headboard and footboard (P1) to the side rail (P2) using hardware :

- A = 8pcs
- C = 8pcs
- D = 4pcs
- E = 8pcs

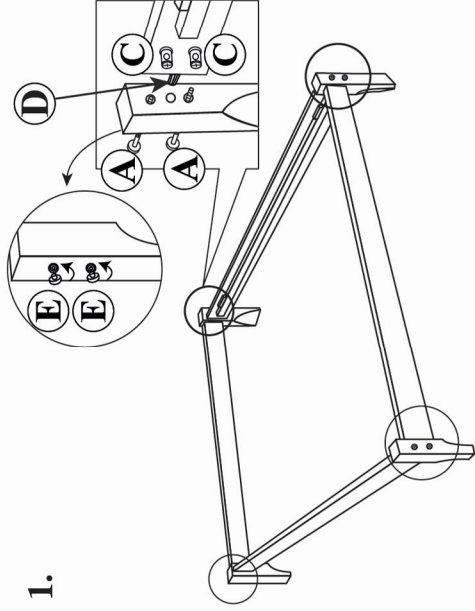

## PART LIST

P1	Headboard Footboard	= 1set
P2	Side Rail	= 2pcs
P3	Centre Rail	= 1pcs
P4	Support leg	= 2pcs
P5	Bed Slats (Q/K)	= 15pcs

Fix the adjuster (H) to the support leg (P4) using hardware :

- H = 2pcs

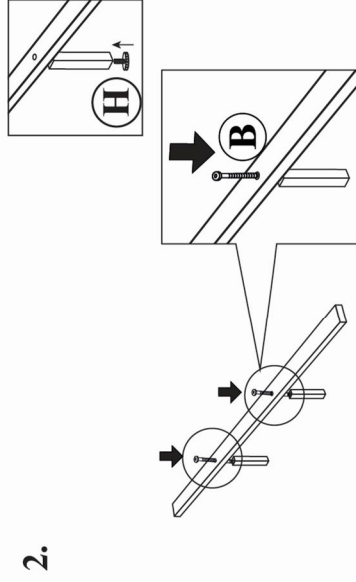

Attach the support legs (P4) to the centre rail (P3) using hardware :



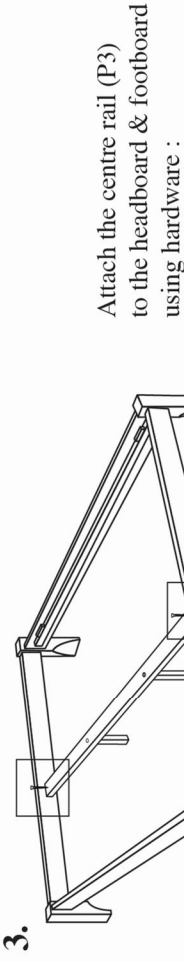





- B = 2pcs



Attach the centre rail (P3) to the headboard & footboard using hardware :

- F = 2pcs

## HARDWARE LIST

A	 M6 x 90mm JCBC	8pcs
B	 M6 x 50mm JCBC	2pcs
C	 BARREL NUT	8pcs
D	 Ø8 x 35mm WOOD DOWEL	4pcs
E	 WOODEN PLUG	8pcs
F	 M4 X 25mm SCREW (Q/K)	35pcs
G	 ALLEN KEY	1pcs
H	 ADJUSTER	2pcs

Lay the slats (P5) between the side rail (P2) using hardware :

- F = 30pcs (Q/K)

Attach the slats (P5) to the centre rail (P3) using hardware :

- F = 3pcs

