

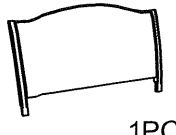

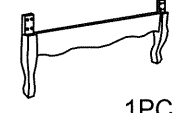









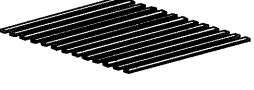



ASSEMBLY INSTRUCTION

OLIVER FULL BED / QUEEN BED / KING BED

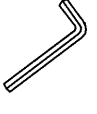
A HEADBOARD PANEL	B HEADBOARD LEG PANEL	C FOOTBOARD PANEL	D SIDE RAILS
			
1PC	1PC	1PC	2PCS
E CENTER SUPPORT	F SUPPORT LEG	G BED SLATS	H JCBB M8 X 25MM
			
1PC	3PCS	1SET (13PCS)	8PCS
I JCBC M6 X 60MM	J JCBC M6 X 40MM	K JCBC M6 X 15MM	L SPRING WASHER M8
			
3PCS	8PCS	4PCS	8PCS
M SPRING WASHER M6	N FLAT WASHER M8	O ALLEN KEY M5	P ALLEN KEY M4
			
8PCS	8PCS	1PC	1PC
Q ADJUSTER M6	R L/BACKET	S CSK M4 X 32MM	
			
3PCS	2PCS	26PCS	

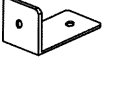

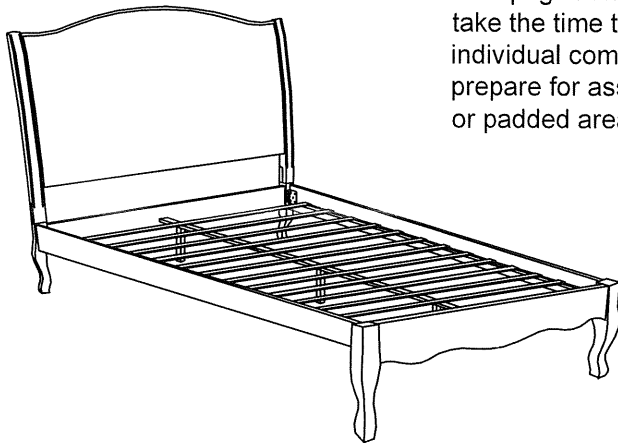
This page lists all the contents included in the box. Please take the time to identify the hardware as well as the individual components to this product. As you unpack and prepare for assembly, place the contents on the carpeted or padded area to protect them from damage.

- 1** Insert JCBB M8 X 25mm (H) Flat Washer M8 (N) Spring Washer M8 (L) to Side Rail (D) connection Headboard Leg Panel (B)/Footboard Panel (C) by Allen Key M5 (O).

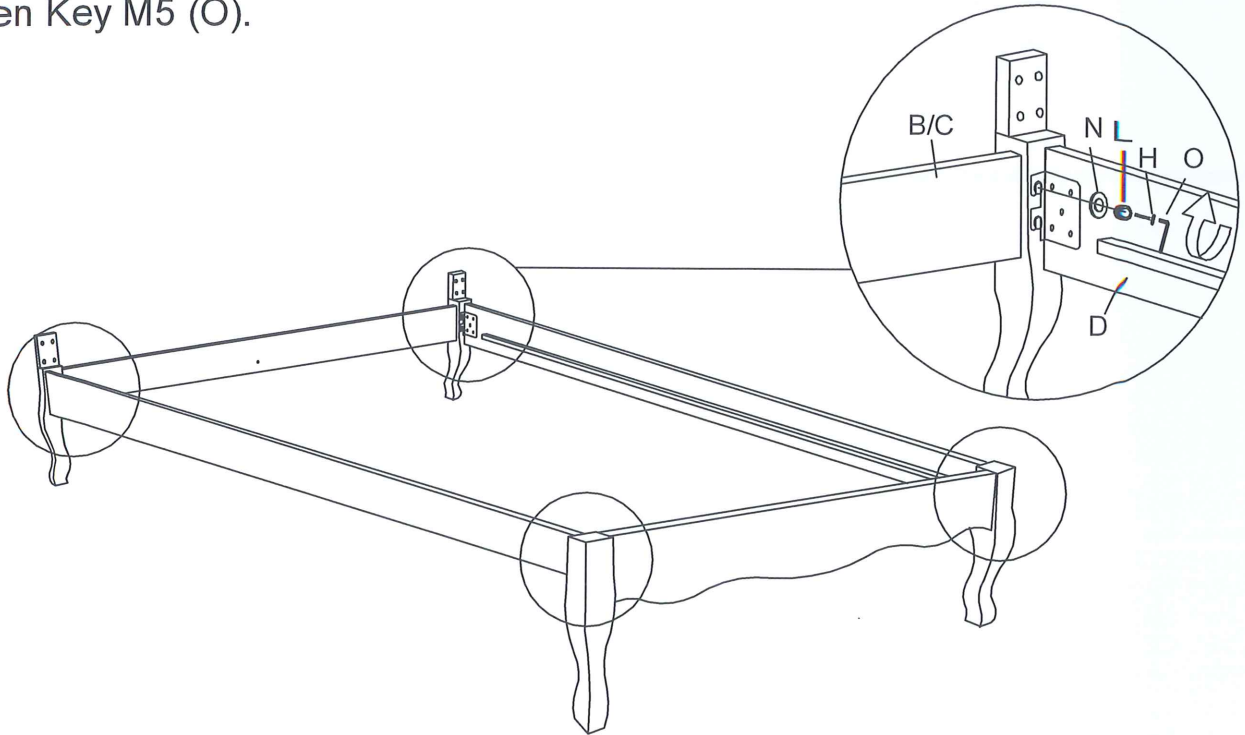

- 2** Insert JCBC M6 X 15mm (K) to L/Bracket (R) to Center Support (E) connection Headboard Leg Panel (B)/Footboard Panel (C) by Allen Key M4 (P).

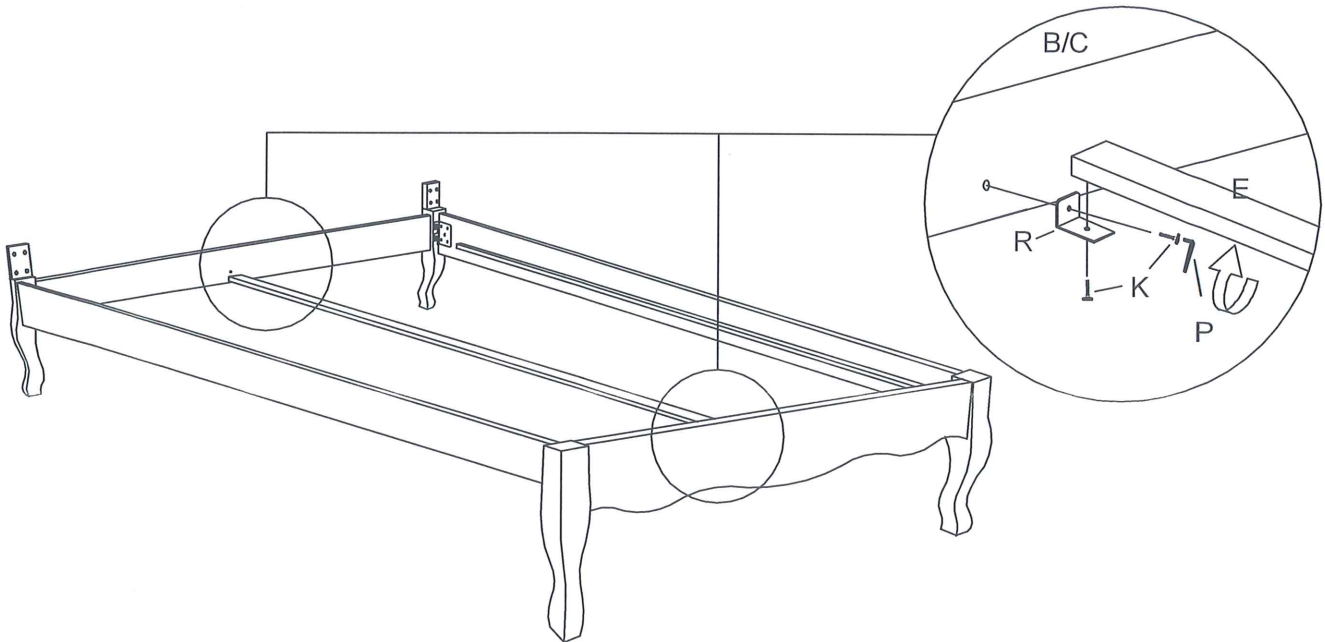

3 Insert JCBC M6 X 60mm (I) to Bed Slats (G) connection Center Support (E) & Support Leg (F) by Allen Key M4 (P) and turn the Adjuster M6 (Q) into the bottom of the Support Leg (F).

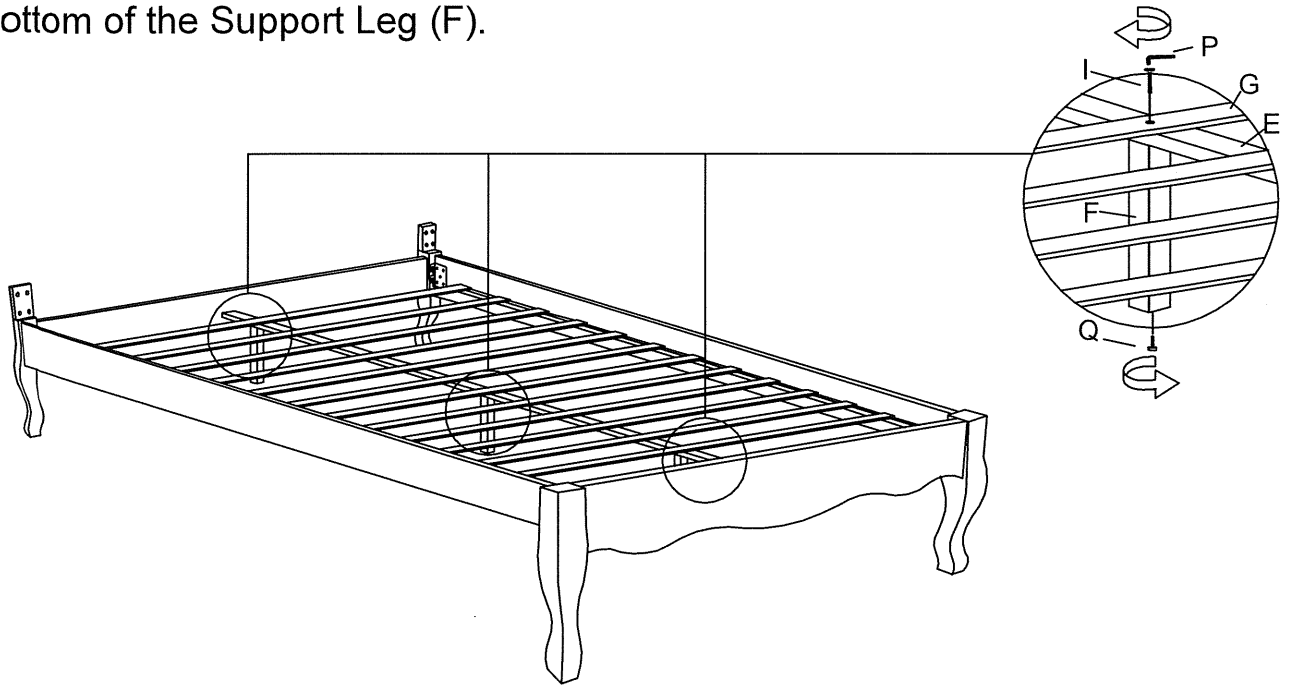

4 Insert CSK M4 X 32mm (S) to Bed slat (G) connection Side Rail Cleat (D).

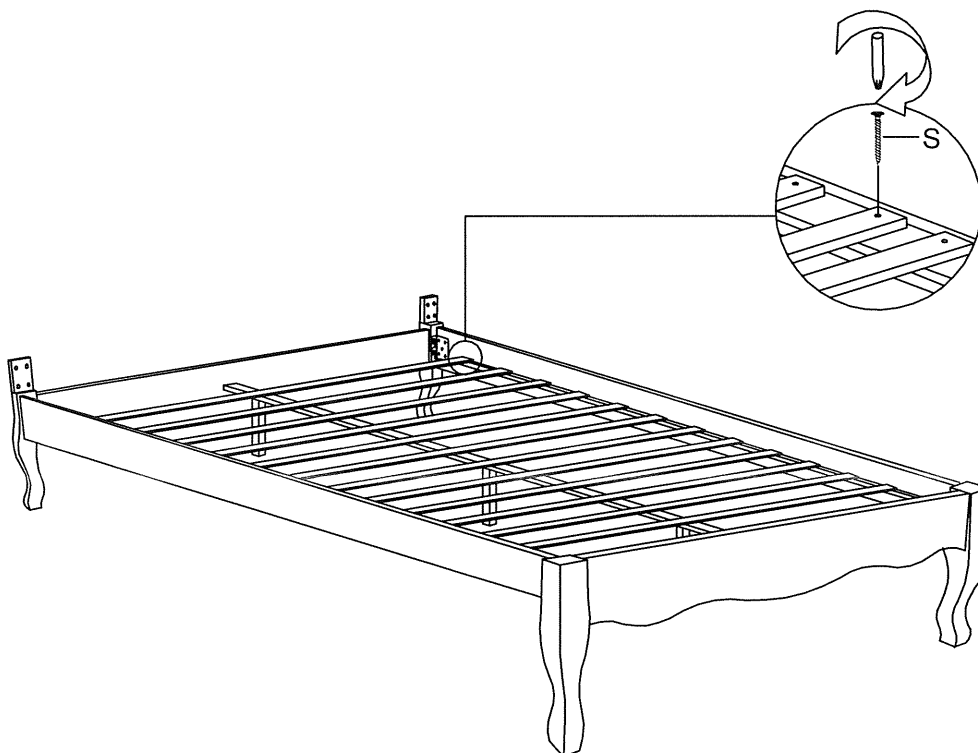

5 Insert JCBC M6 X 40mm (J), Spring Washer M6 (M) to Headboard Panel (A) connection Headboard Leg Panel (B) by Allen Key M4 (P).

