

4810 King Bed

Assembly Instructions

121217

1 Assembled View

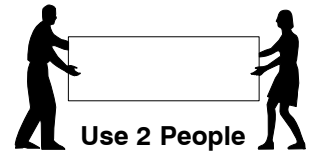
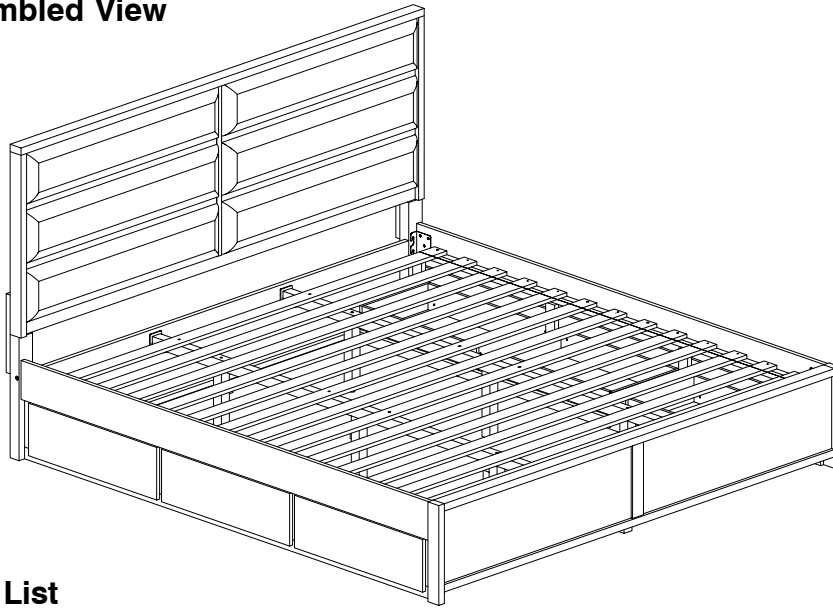

Note: Do not assemble using power tools. This can cause the bolts to be overtightened

2 Parts List

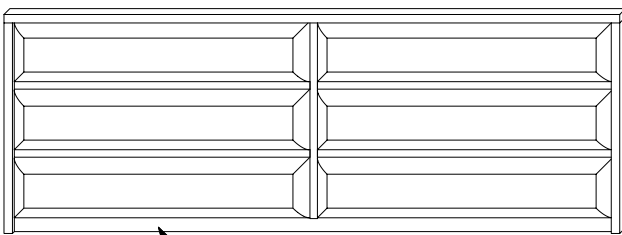

A Headboard x 1

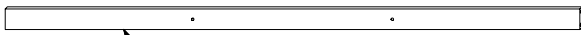

B Headboard Rail x 1

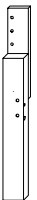

C Headboard Leg (Left Hand) x 1



D Headboard Leg (Right Hand) x 1

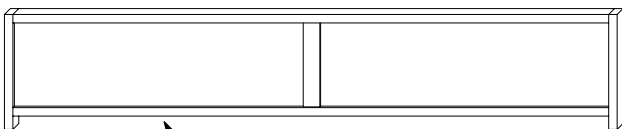

E Footboard x 1



L Drawer Face x 6

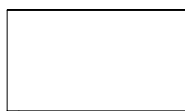

M Drawer Bottom x 6



N Drawer Back x 6



O Drawer Side x 12



P Drawer Rail x 6

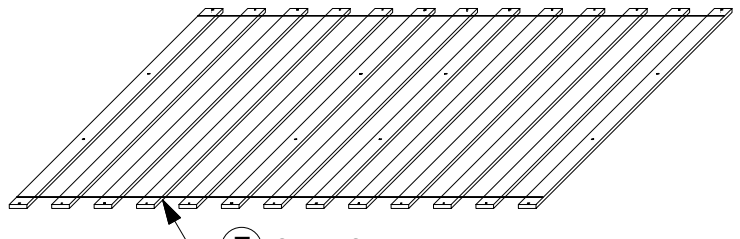

F Set of Slats x 1

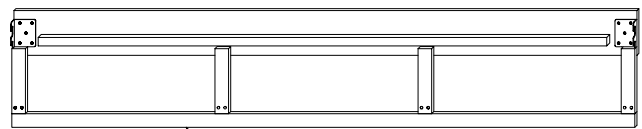

G Stretcher x 2

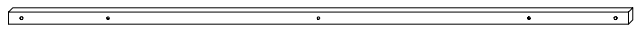

H Center Rail x 2

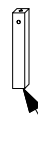

J Center Leg x 6



K Foot x 2

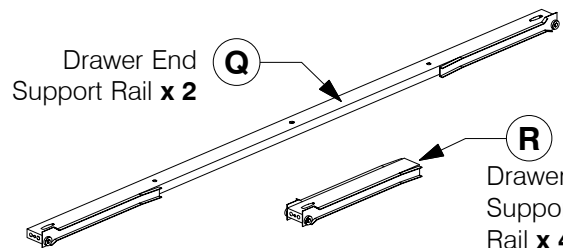

Drawer End Support Rail x 2

R Drawer Support Rail x 4



S Support Rail x 2

4810 King Bed

Assembly Instructions

121217

3 Hardware List



1 M6 x 90mm JCB
x 8



2 M6 x 50mm JCB
x 6

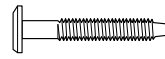

3 M6 x 40mm JCB
x 24



4 M6 x 25mm JCB
x 8



5 M6 x 15mm JCB
x 8



6 Wood Dowel
(10 x 40mm) x 2



7 Wood Dowel
(8 x 30mm) x 16



8 Wood Dowel
(6 x 25mm) x 24



9 Barrel Nut
x 6



10 Spring Washer
x 14



11 Flat Washer
x 14



12 Wood Screw
(M4 x 32mm) x 28

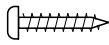

13 Wood Screw
(M4 x 25mm) x 60

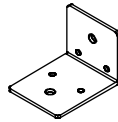

14 Center Rail
Bracket x 4



15 Allen Key x 1

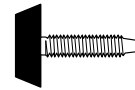

16 Adjustable
Foot x 6

4 Assembled the Center Legs (J) to the Center Rail (H).

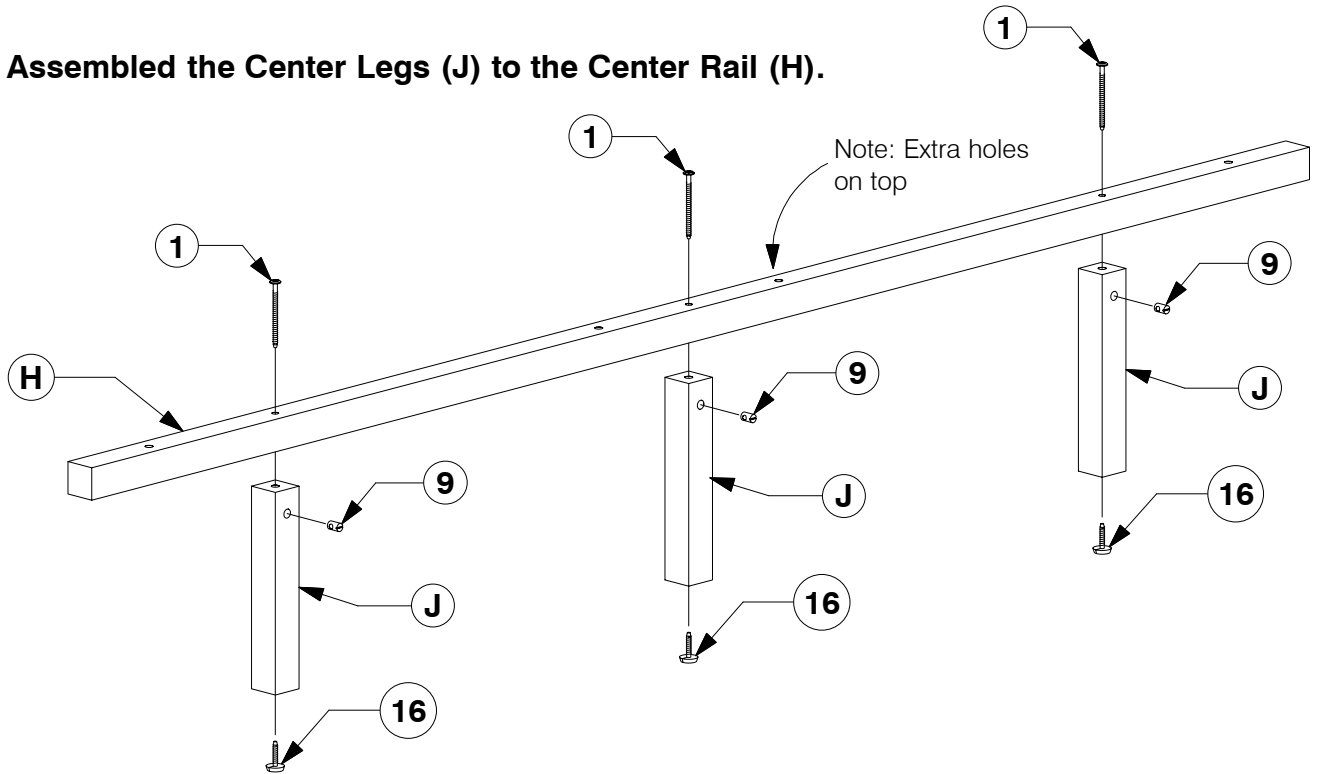

5 Assembled a Foot (K) to each Support Rails (Q)

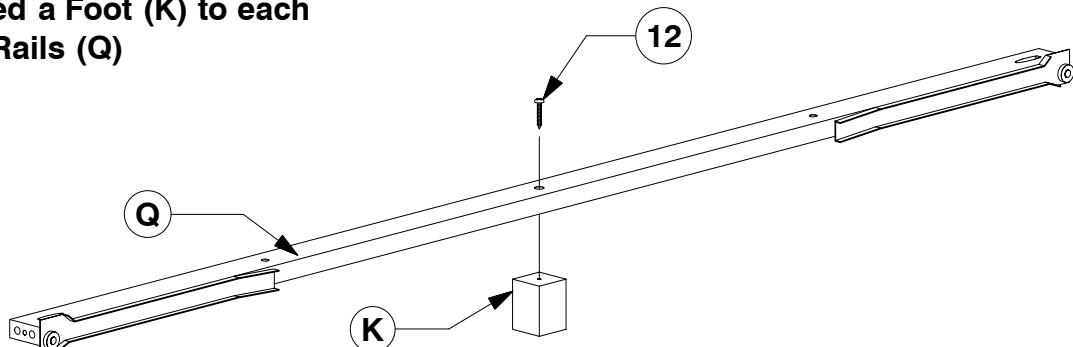

4810 King Bed

Assembly Instructions

121217

- 6 Assemble the Drawer Sides (O) and Drawer Rail (P) to the Drawer Back (N).
Make sure the small wheels on the Drawer Sides (O) are next to the Drawer Back (N).**

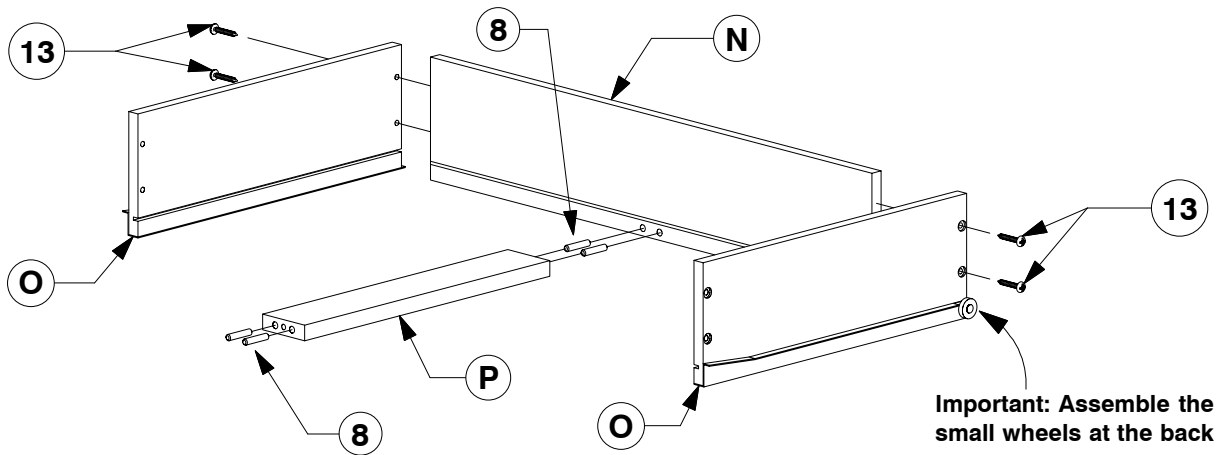

- 7 Slide the Drawer Bottom (M) into the groove on the Drawer Sides (O).**

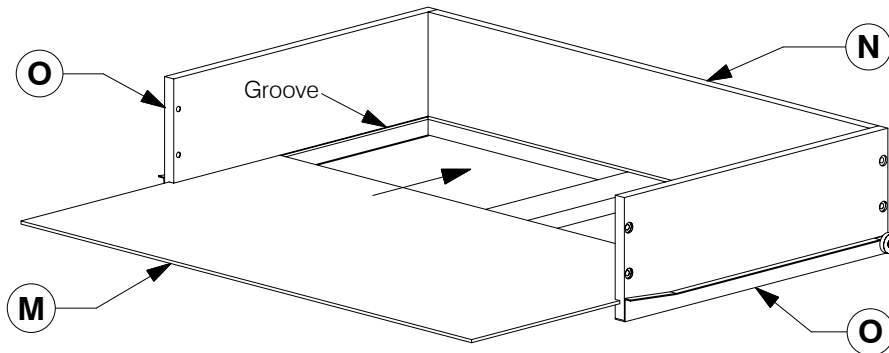

- 8 Assemble the Drawer Face (L) to the Drawer Sides (O).**

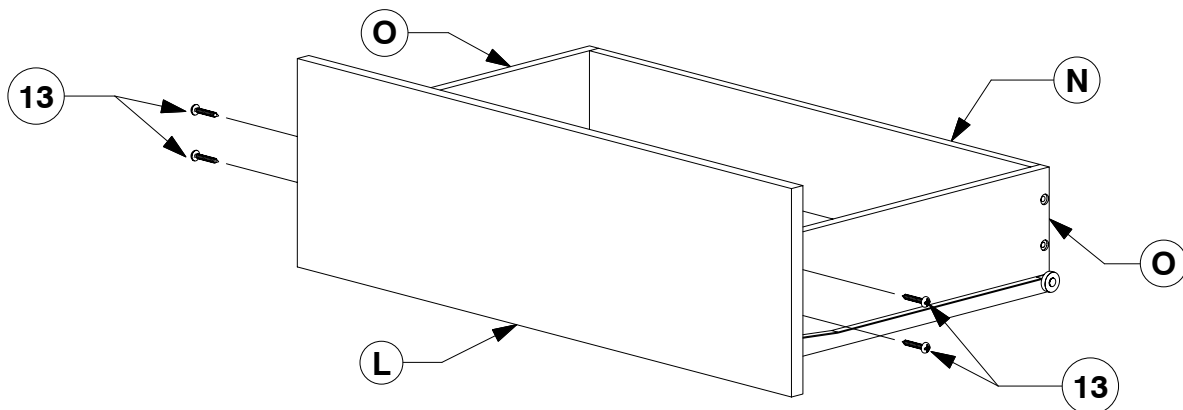

- 9 Turn the Drawer over to fit angled 25mm Wood screws (13) to the Drawer Rail (P).**

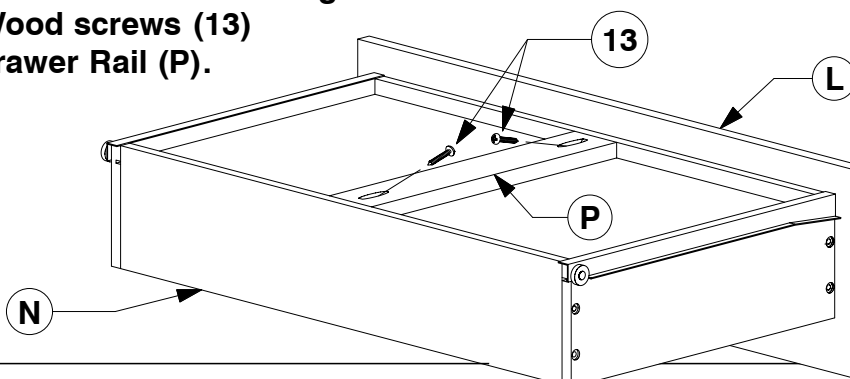

4810 King Bed

Assembly Instructions

121217

- 10 Assemble the Headboard Legs (C & D) to the Headboard Rail (B).**

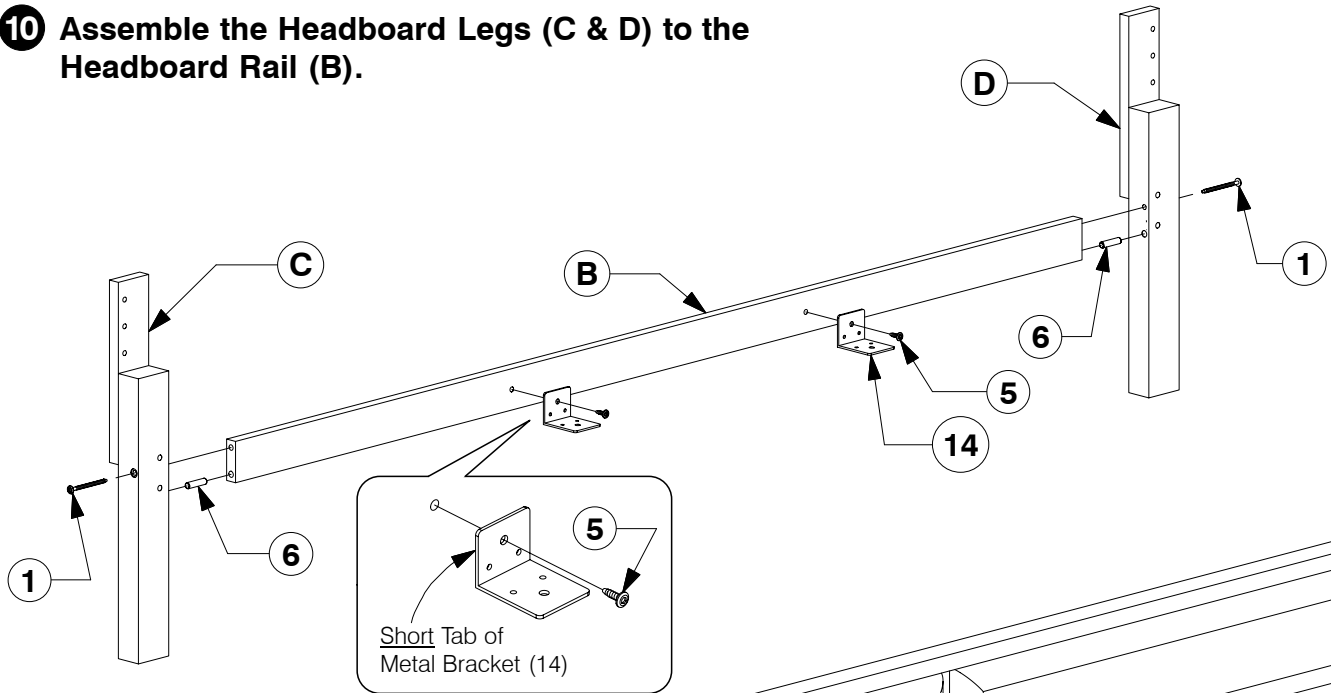

- 11 Assemble the Headboard Panel (A) to the Headboard Legs (C & D).**

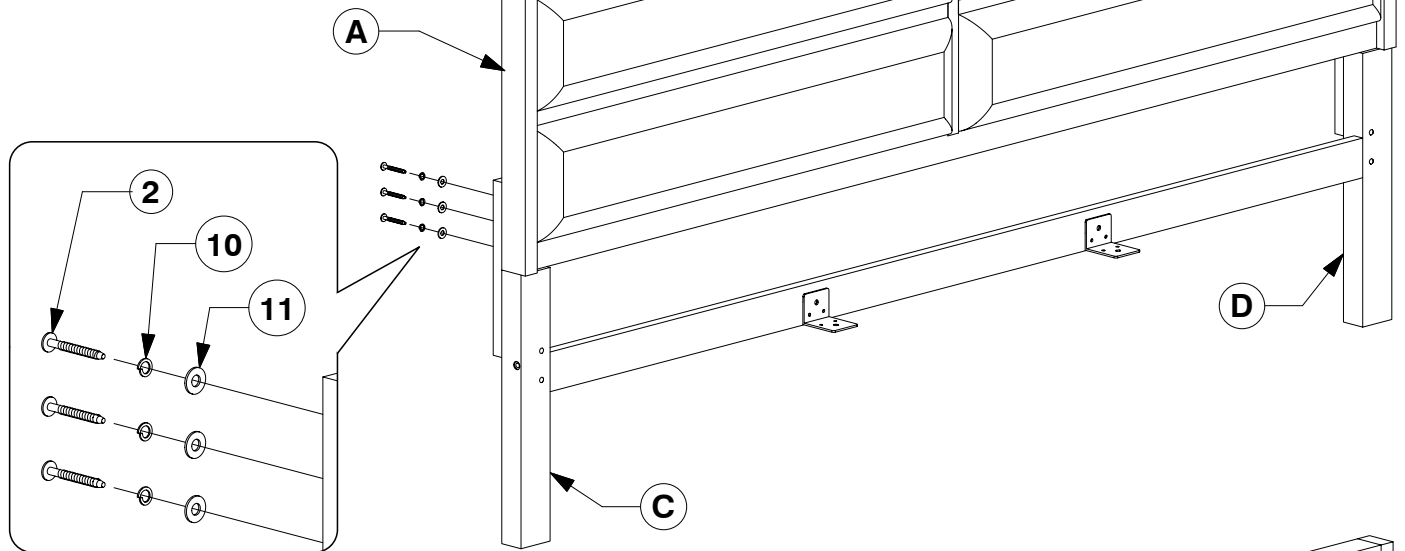

- 12 Fit the Metal Bracket (14) to the Footboard (E).**

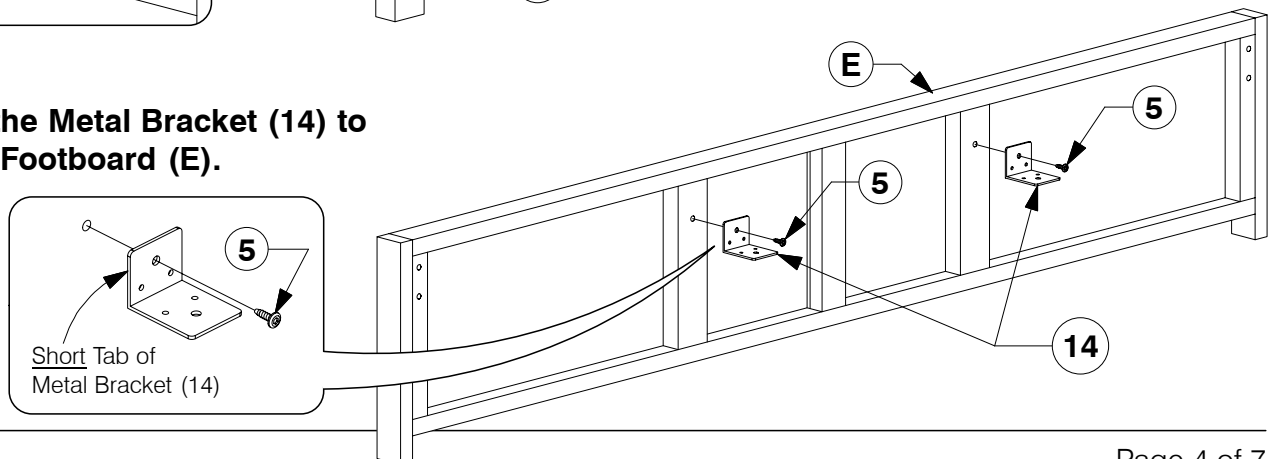

4810 King Bed

Assembly Instructions

121217

- 13** Screw the Stretchers (G) to Drawer End Support Rails (Q) and Drawer Support Rails (R).

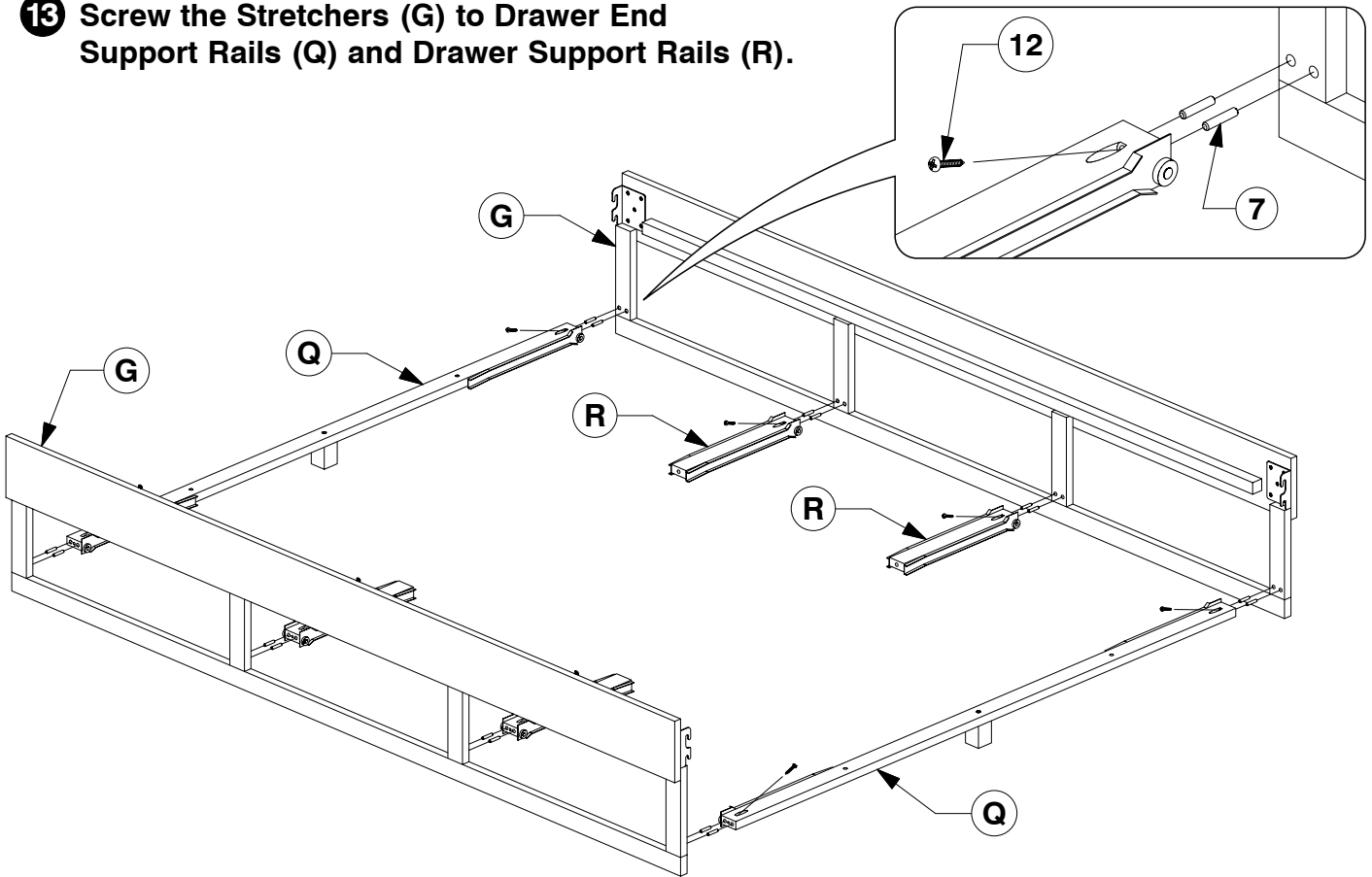

- 14** Bolt the Support Rail (S) to the Drawer End Support Rails & Drawer Support Rails (Q & R).

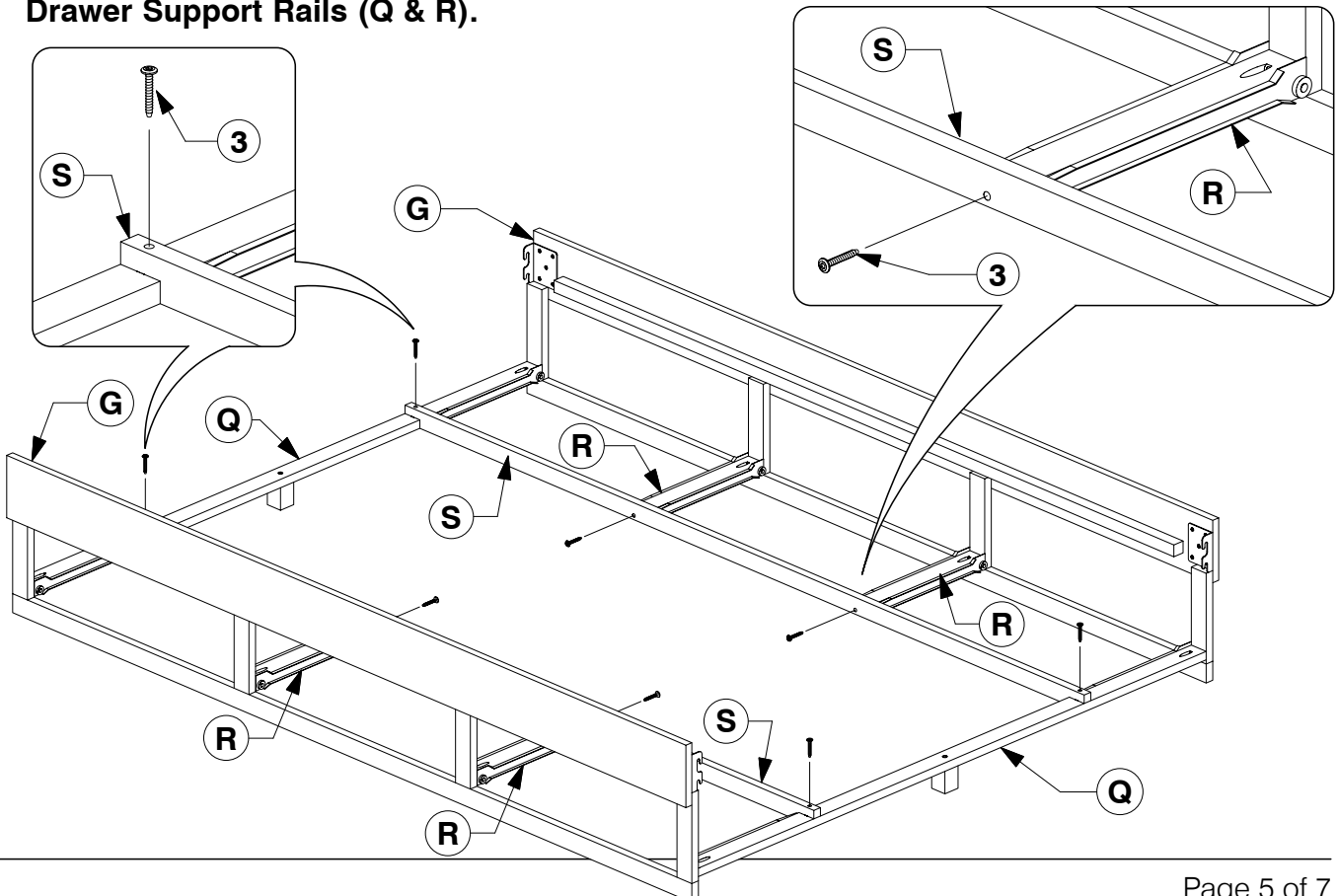

4810 King Bed

Assembly Instructions

121217

- 15** Assemble the Stretchers (G) to the assembled Headboard (A) and Footboard (E).

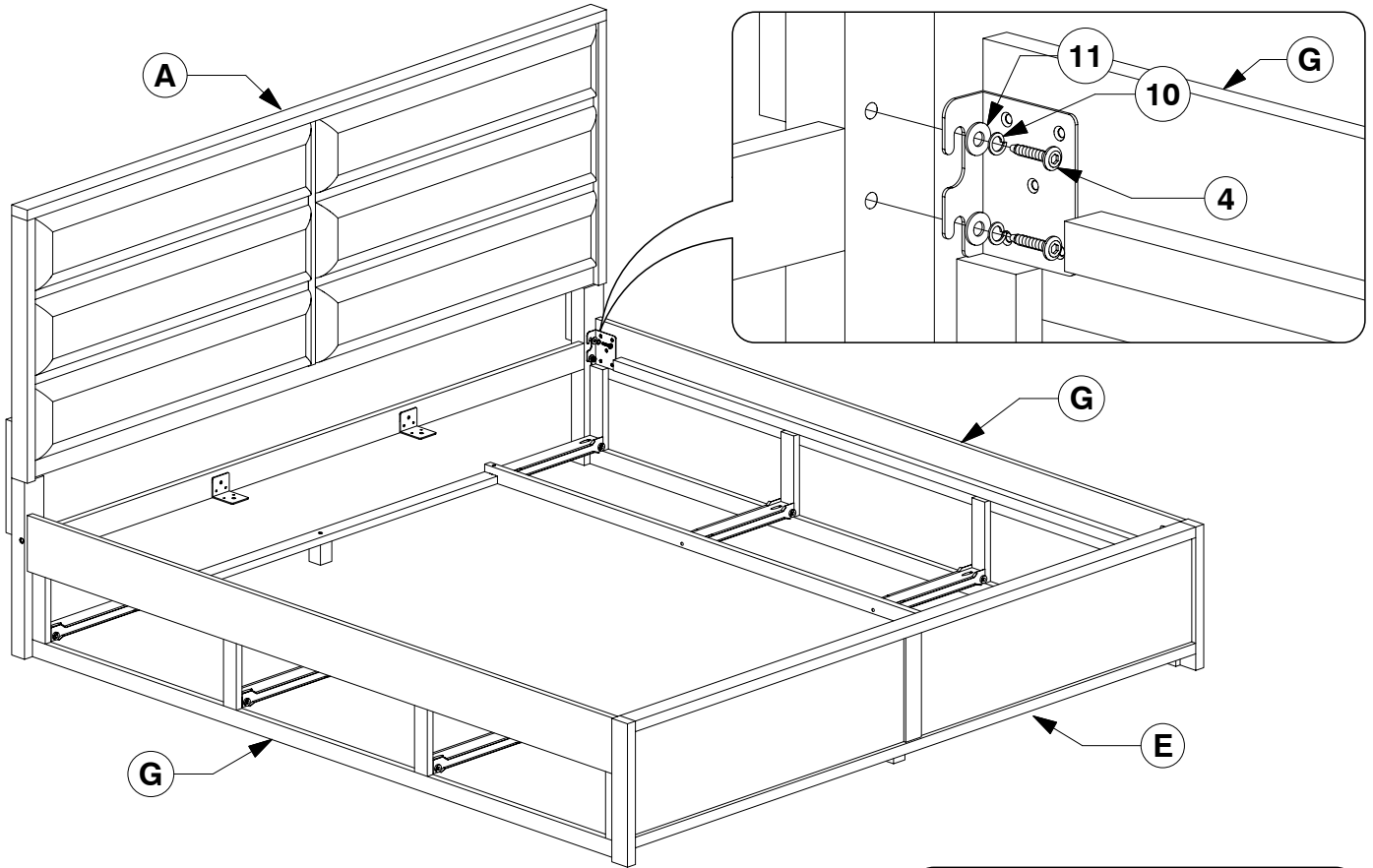

- 16** Bolt the Center Rail (H) to the Metal Brackets (14) on the Headboard Rail (B) and Footboard (E).

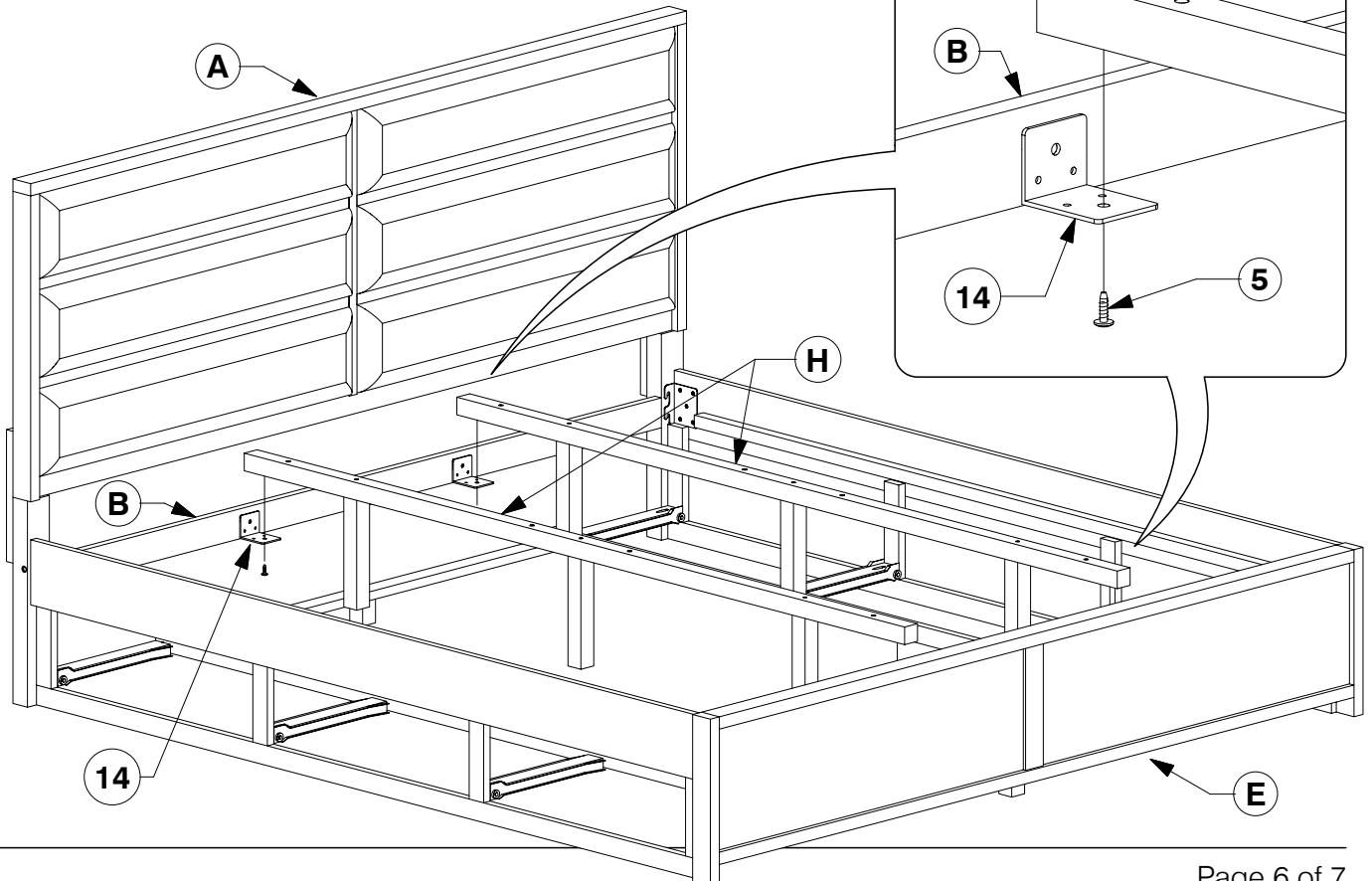

4810 King Bed

Assembly Instructions

121217

17 Bolt the Slats (F) to the Stretchers (G).

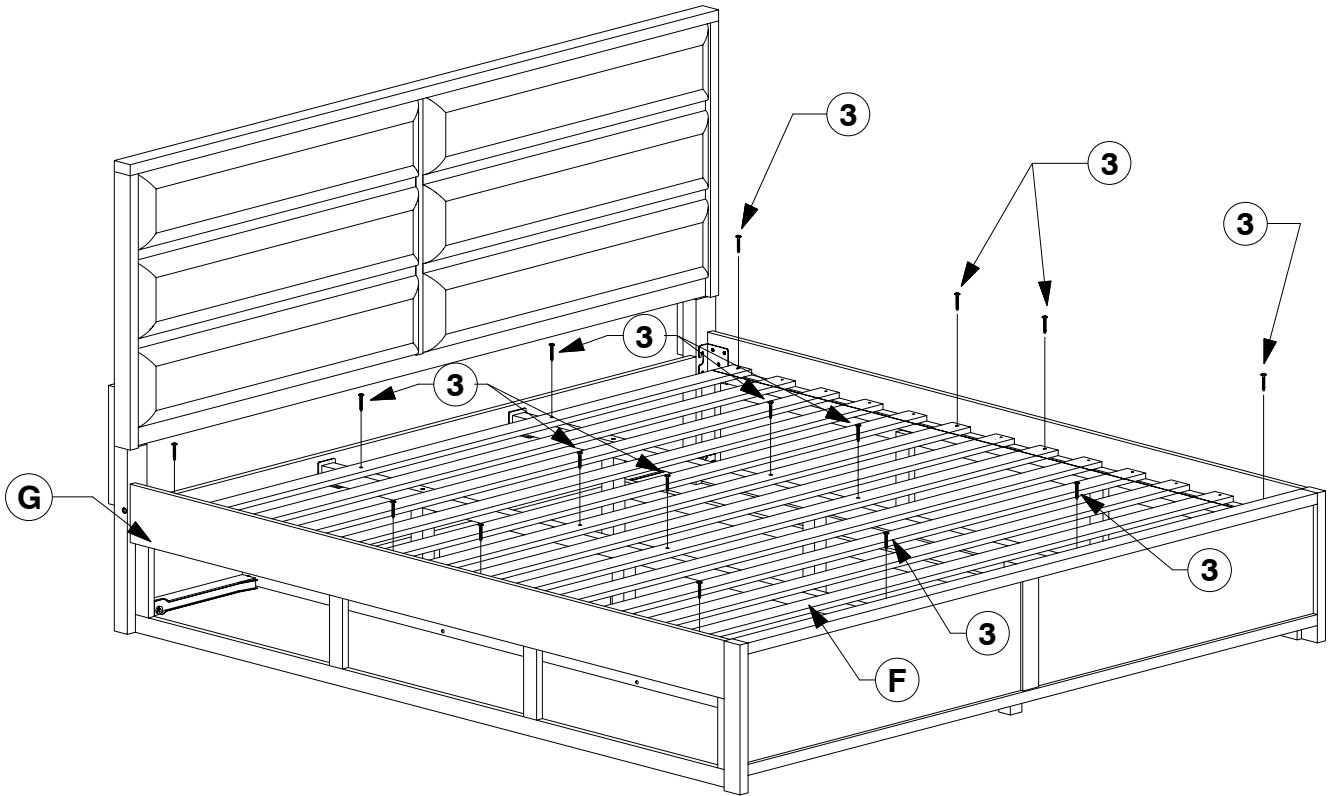

18 Screw the Slats (F) to the Stretchers (G).

Finally fit the assembled Drawers.

