









ASSEMBLY INSTRUCTIONS

MODEL : LW120-T

Please follow the assembly instruction carefully step by step. Place all wooden parts on a clean and flat surface such as carpet or rug to avoid the parts from being scratched. Make sure the barstool does not wobble before use. Keep all hardware out of reach of small children.

ITEM	PART NAME	QTY
1	Back Rest 	1 PC
2	Front Leg 	2 PC
3	Seat 	1 PC

ITEM	HARDWARE NAME	DESCRIPTION	QTY
A	JCBC BOLT (LONG)		4 PCS
B	JCBC BOLT (MEDIUM)		4 PCS
C	JCBC BOLT (SHORT)		2 PCS
D	SPRING WASHER		10 PCS
E	FLAT WASHER		10 PCS
F	ALLEN KEY		1 PC

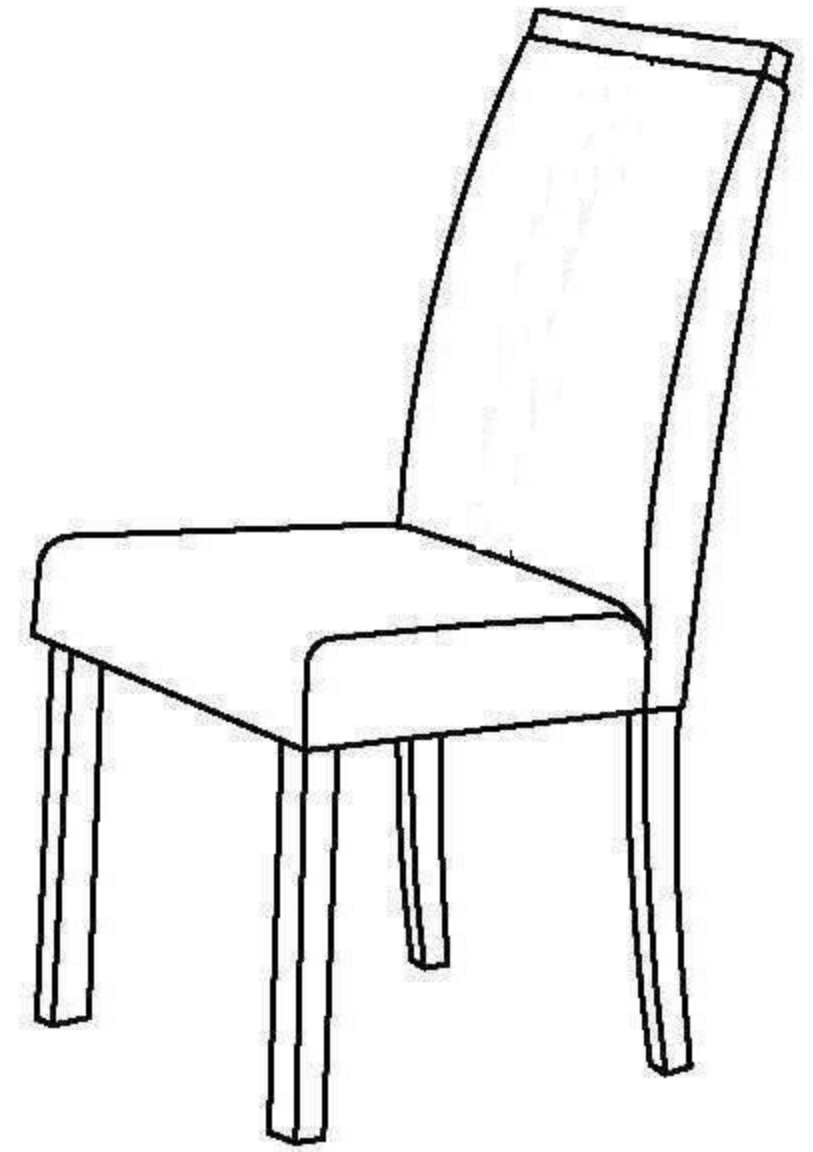

FULLY SET-UP

STEP 1 Screw in Cushion Seat to Backrest using JCBC Bolt (Short), Spring Washer & Flat Washer.

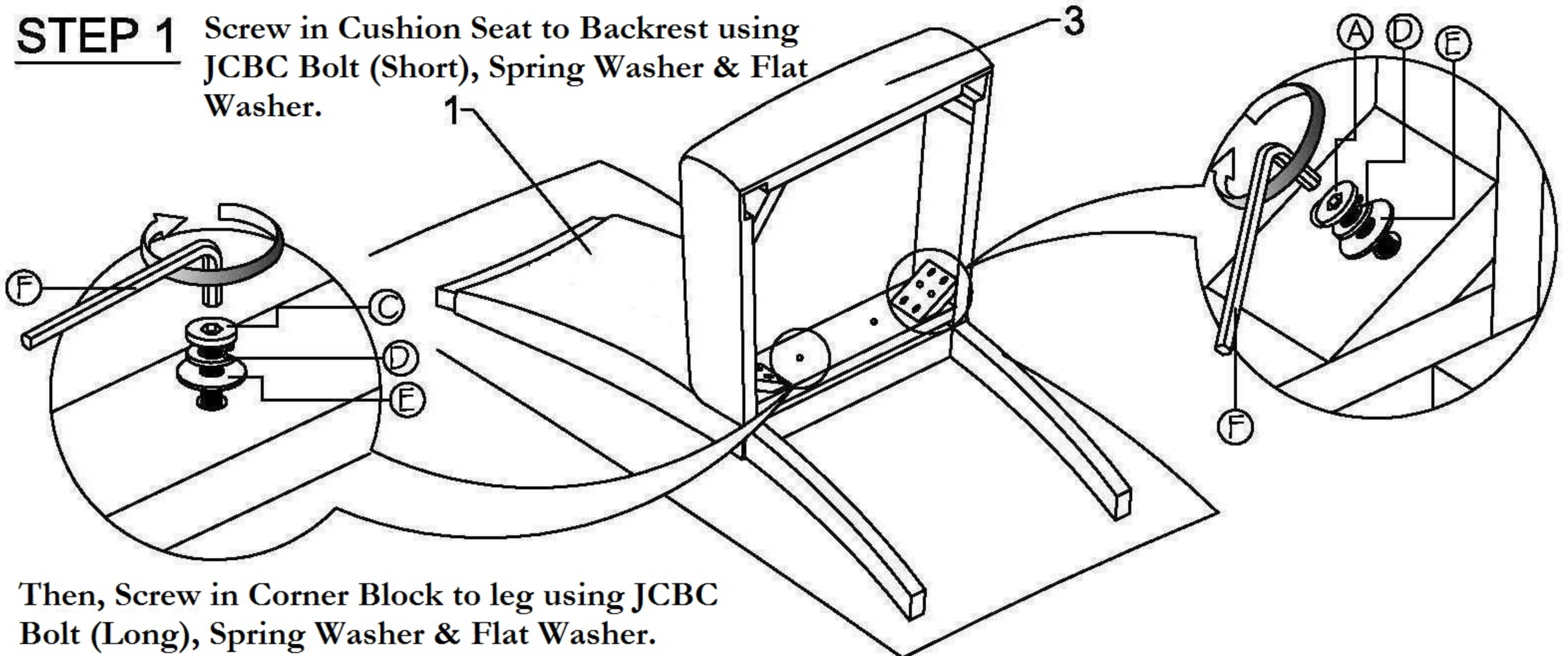

Then, Screw in Corner Block to leg using JCBC Bolt (Long), Spring Washer & Flat Washer.

STEP 2 Screw in Chair Front Leg to Cushion Seat using JCBC Bolt (Medium), Spring Washer & Flat Washer.

