

ASSEMBLY INSTRUCTION

IMPRORANT NOTE: *PLACE ALL PARTS ON CLEAN AND SMOOTH SURFACE SUCH AS RUG OR CARPET TO AVIOD THE PARTS FROM BEING SCRATCHED.
*KINDLY FOLLOW THE ASSEMBLY INSTRUCTIONS STEP BY STEP.
*DO NOT TIGHTEN ALL SCREWS UNTIL THE BED IS FULLY SET-UP.

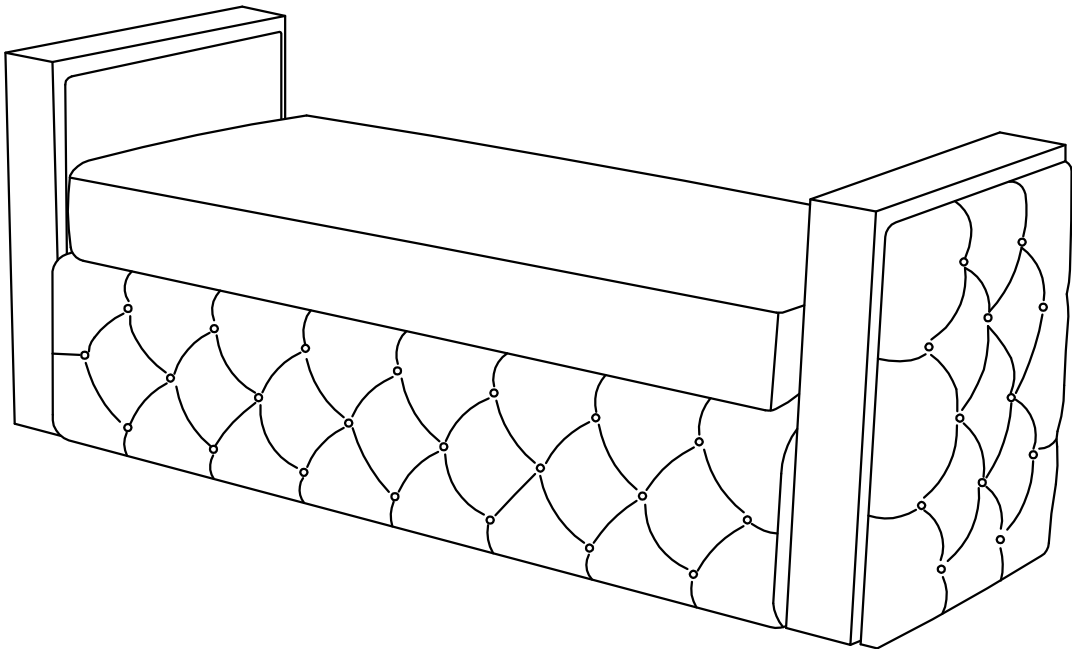

PARTS LIST

1 FRONT PANEL 2PCS





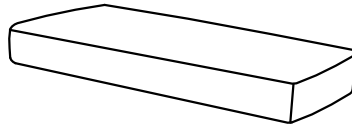
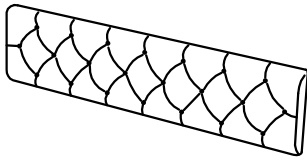

2 CUSHION 1PC

3 ARM 2PCS



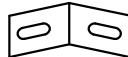

4 BOTTOM PANEL 2PCS

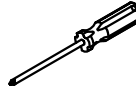

HARDWARE LIST

 M8x30 Ax16	 Ø8-Ø20 Bx16	 Ø8 Cx16	 M5 Dx1	 M5 Ex8
 M5x20 Fx10	 HINGE Gx2	 SCREW DRIVER (NOT PROVIDED)		

1

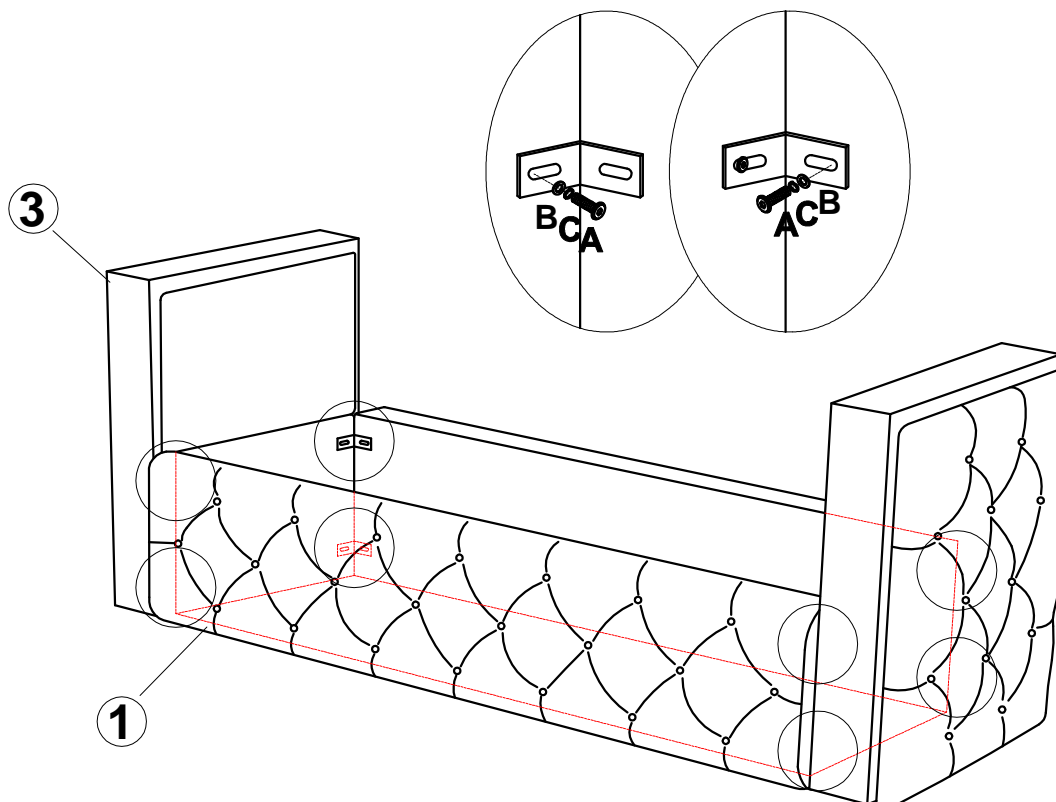

 M8x30 Ax16	 Ø8-Ø20 Bx16	 Ø8 Cx16	 M5 Dx1	 M5 Ex8
---	--	--	---	---

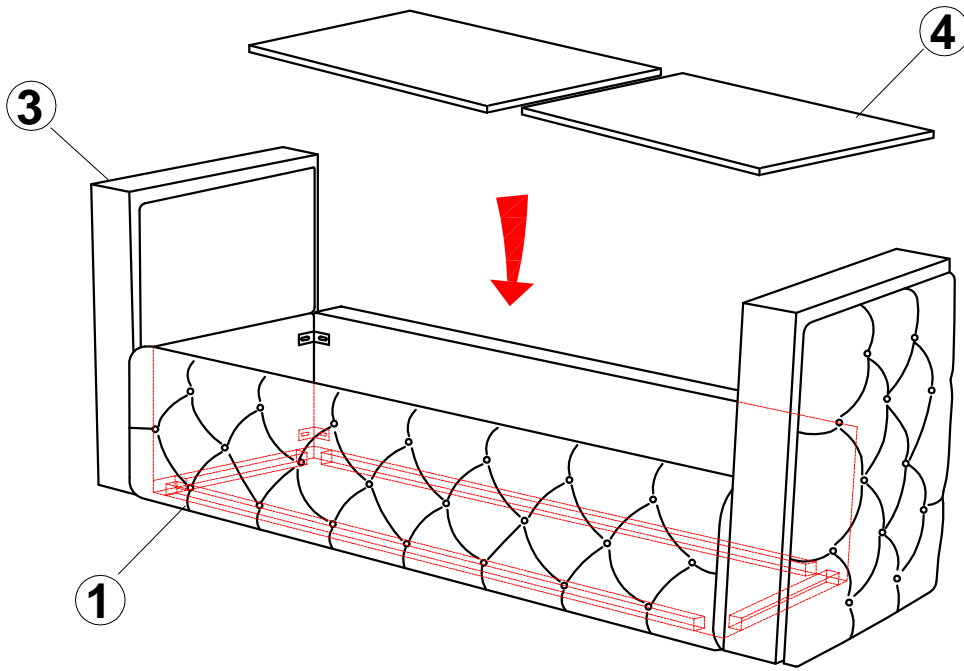

2

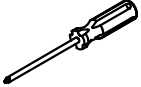

3

 M5x20 Fx10	 HINGE Gx2	 NOT PROVIDE
---	--	--

