



ASSEMBLY INSTRUCTION

MODEL: COUNTER MARBLE TABLE

Important note: - Place all wooden part on a clean and smooth surface such as rug or carpet to avoid the part from being scratch.
- Please follow the assembly instruction step by step.
- Do not tighten all screw until the table is fully set-up.

Hardware List

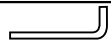
No	DESCRIPTION	QTY.
A	JCBC M8 x 60mm 	8 pcs
B	Washer 	8 pcs
C	Spring Washer 	8 pcs
D	Allen Key 	1 pc

Part List

No	DESCRIPTION	QTY.
1	Table Top	1 pc
2	Table Leg	4 pcs

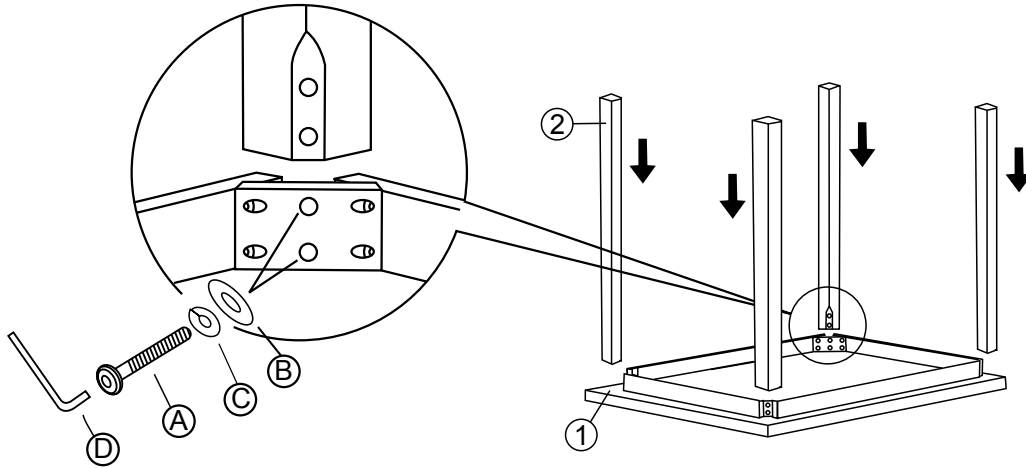
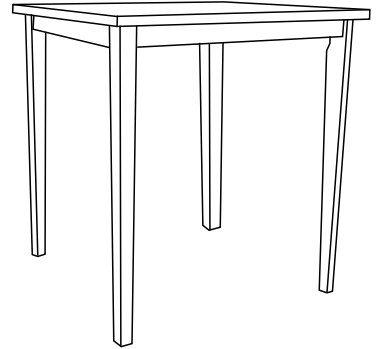



ASSEMBLY INSTRUCTION

MODEL: COUNTER MARBLE TABLE

Important note: - Place all wooden part on a clean and smooth surface such as rug or carpet to avoid the part from being scratch.
- Please follow the assembly instruction step by step.
- Do not tighten all screw until the table is fully set-up.

Hardware List

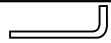
No	DESCRIPTION	QTY.
A	JCBC M8 x 60mm 	8 pcs
B	Washer 	8 pcs
C	Spring Washer 	8 pcs
D	Allen Key 	1 pc

Part List

No	DESCRIPTION	QTY.
1	Table Top	1 pc
2	Table Leg	4 pcs

