

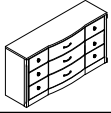





# ASSEMBLY INSTRUCTIONS

DESCRIPTION : MIRROR / DRESSER

Place all wood parts on a clean and smooth surface to keep them from being scratched.

ITEM	DRAWING	DESCRIPTION	QTY
A		DRESSER	1
B		MIRROR	1
C		MIRROR SUPPORT	2
D		JCBC M6 x 35mm	8
E		SPRING WASHER M8	8
F		FLAT WASHER M8	8
G		ALLEN KEY M4	1

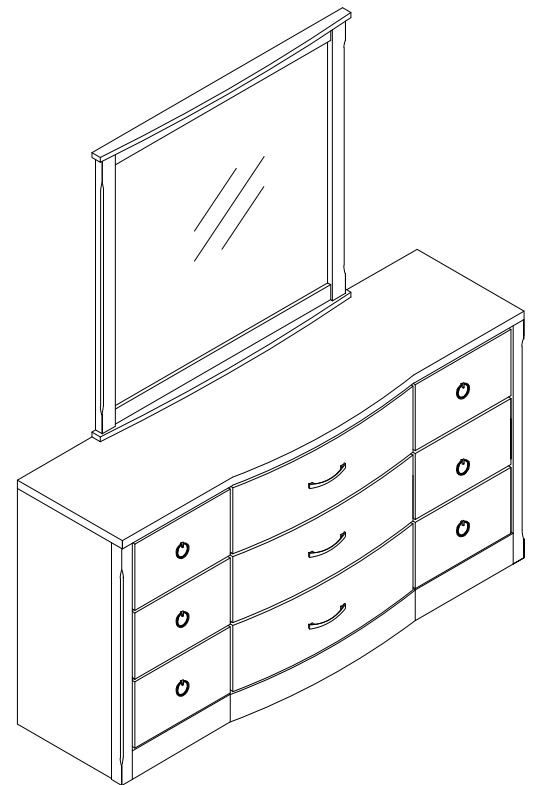

COMPLETED DRESSER & MIRROR ASSEMBLY

## STEP 1

Attach & tighten the Mirror to the Mirror Support and fasten using JCBC screws(D) ringed with a Spring Washer(E) and Flat Washer(F) as shown.

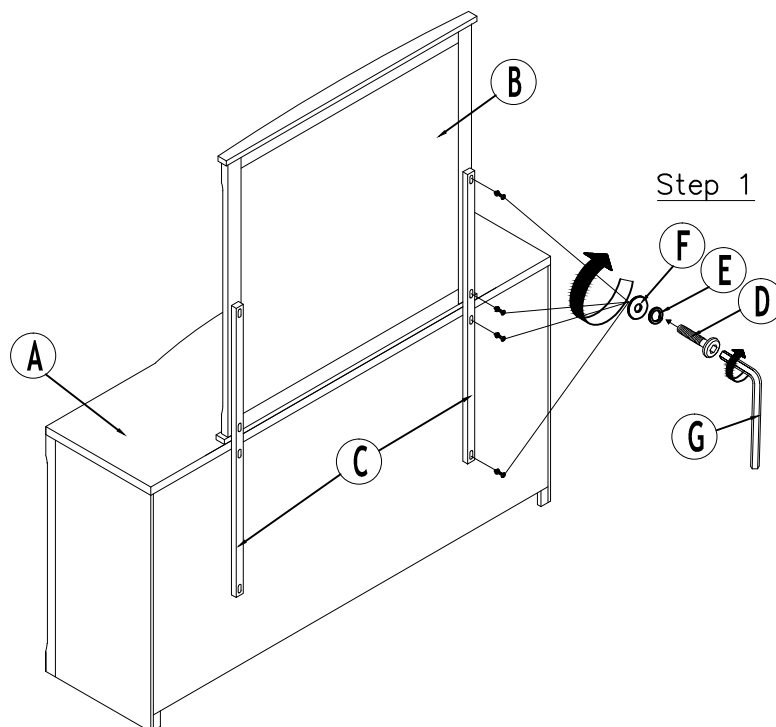

Step 1

NOTE: SCREWS LOOSEN WITH USE.  
CHECK FOR LOOSE SCREWS AND TIGHTEN EVERY 6-8 WEEKS

## CLEANING INSTRUCTIONS:

If necessary, clean & polish all surfaces after assembly with a soft cloth and industrial furniture polish.

MADE IN MALAYSIA