

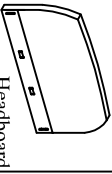







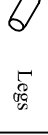

ASSEMBLY INSTRUCTION

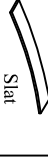
MODEL: CF 8814 (6')

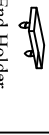
A		1 pc
B		1 pc
C		2 pcs
D		4 pcs
E		2 pcs
F		4 pcs
G		42 pcs
H		28 pcs
I		28 pcs
J		4 pcs
K		1 pc
L		4 pcs
M		4 pcs
N		8 pcs
L		1 pc

Step 1: Install the legs (D) to footboard (B) and headboard (A).

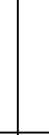
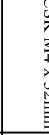
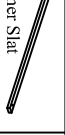
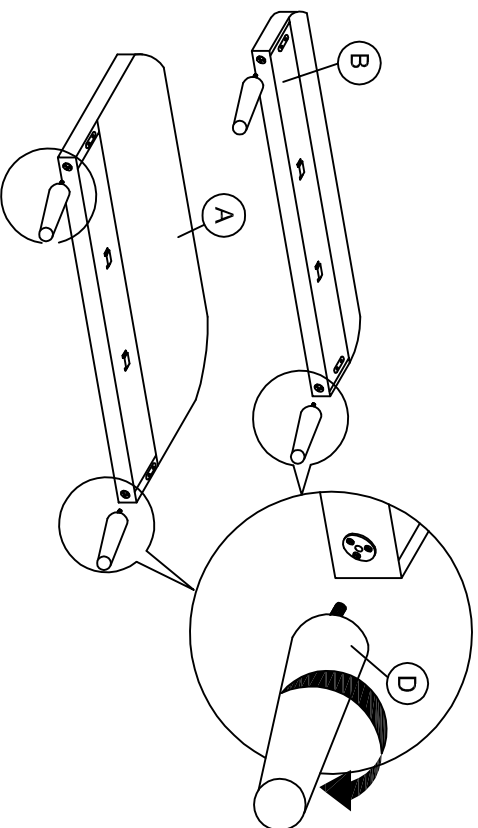

Step 2: Attach side rail (C) to footboard (B) and headboard (A) by pushing the bracket down to fit it.

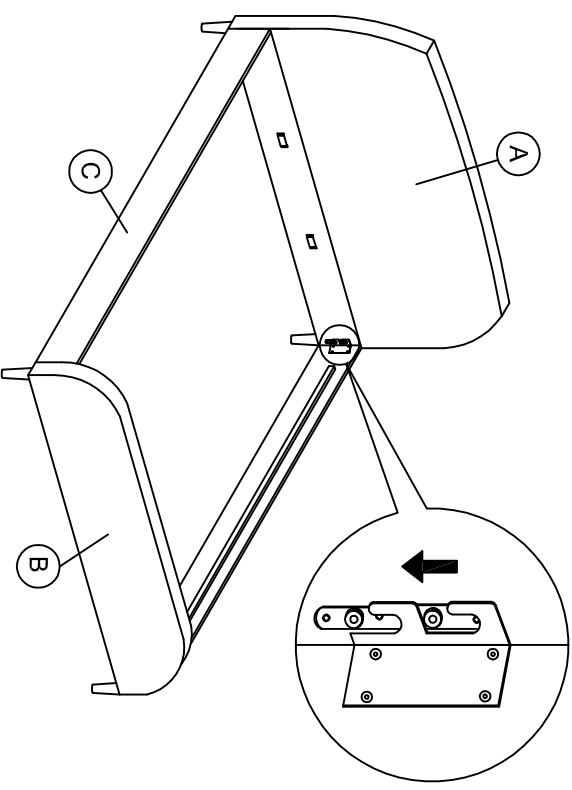

Step 3: Attach the support legs (F) to the center rail (E) of the bed as shown.

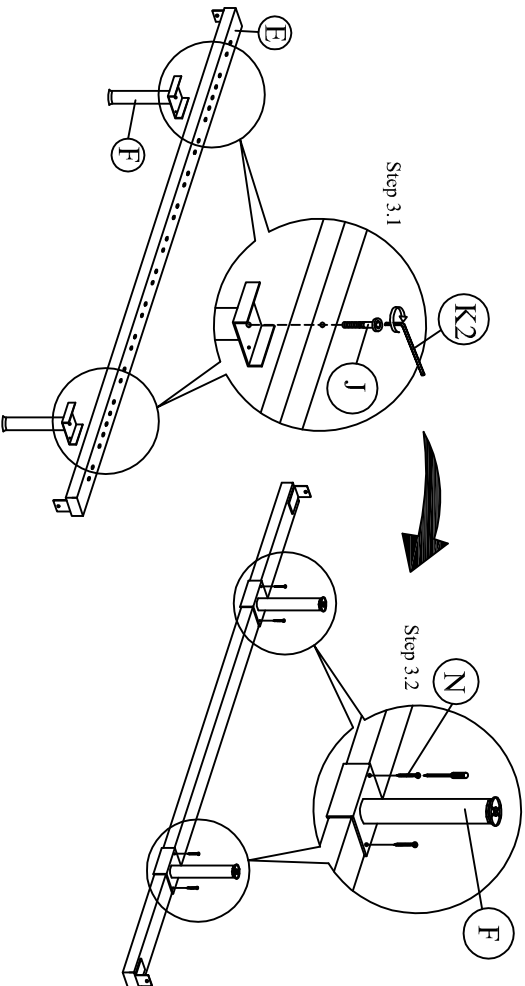

Step 4: Slide the center rail (E) to the headboard (A) and footboard (B). Tighten screws (L) using screw driver (not included) to the headboard (A) and footboard (B).

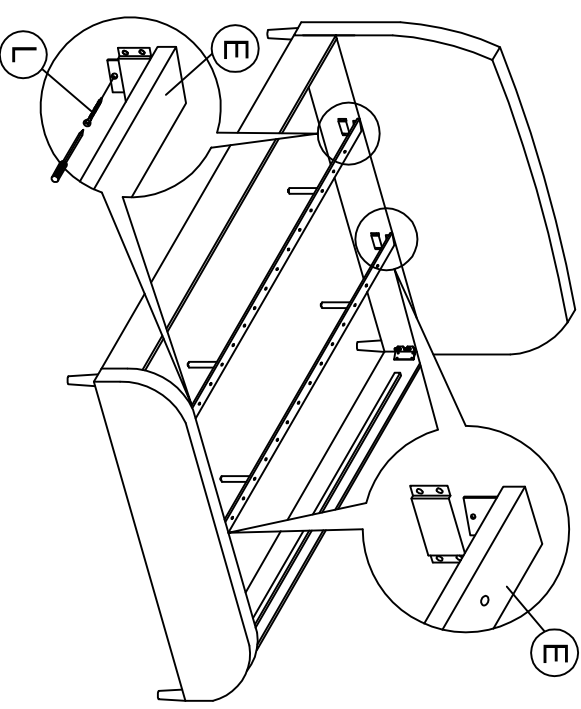

Step 5: Affix the Stiffener Slat (L) to the side rail support wood and the center rail (E) . Tighten all the 4 corner ,follow by a assembly of the slat holders with L VL slats as shown.

