

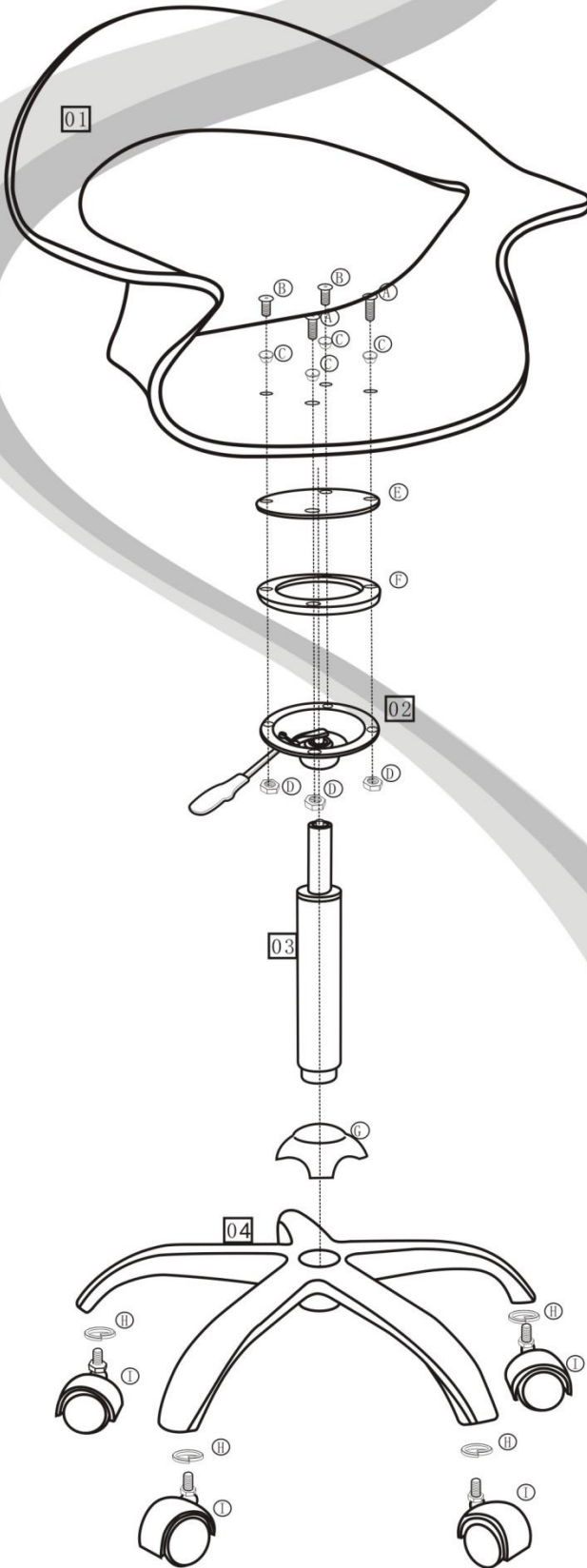









## COMPONENT PARTS

## FITTINGS



- A  \*2
- B  \*2
- C  \*4
- D  \*4
- E  \*1
- F  \*1
- G  \*1
- H  \*5
- I  \*5

## COMPONENT CHECKLIST

PART	No.	Qty.	
Seat	01	1	<input type="checkbox"/>
Bar	02	1	<input type="checkbox"/>
Lift	03	1	<input type="checkbox"/>
Leg	04	1	<input type="checkbox"/>

## TOOLS REQUIRED



Allen key (supplied)

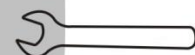

Spanner (supplied)