

MODEL : BBT 6620 TWIN HB

ASSEMBLY INSTRUCTIONS

Read instructions carefully. See furniture and hardware part list on the right for guidance.



Have all parts ready before assembly. Place all wooden furniture parts on a clean and flat soft surface to prevent scratching.

Before you start, here are some words of caution:

1. Do not FULLY - TIGHTEN nuts and bolts until all nuts and bolts are partially tightened.
2. Do not FULLY - TIGHTEN nuts and bolts to avoid causing damage to the threading.
3. Keep all hardware parts out of reach of children.

NOTE : THE LIST AND QUANTITY SHOWN ARE FOR 1 UNIT ASSEMBLY.

FURNITURE PART LIST		
ITEM	DESCRIPTION	QTY
A	HEADBOARD	1 PC
B	SUPPORT BOARD	2 PCS

HARDWARE PART LIST			
ITEM	DESCRIPTION		QTY
1	JCBB BOLT M8 x 60mm		4 PCS
2	M8 FLAT WASHER		4 PCS
3	M5 ALLEN KEY (BALL SHAPE)		1 PC

STEP 1

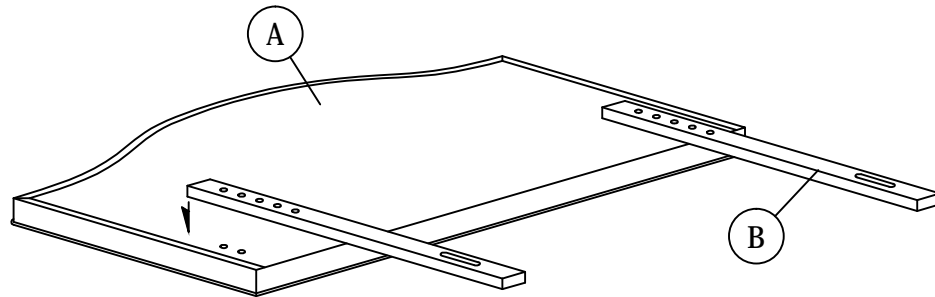

Align pre-drilled support stand holes over the pre-drilled headboard holes according to your desired headboard height

STEP 2

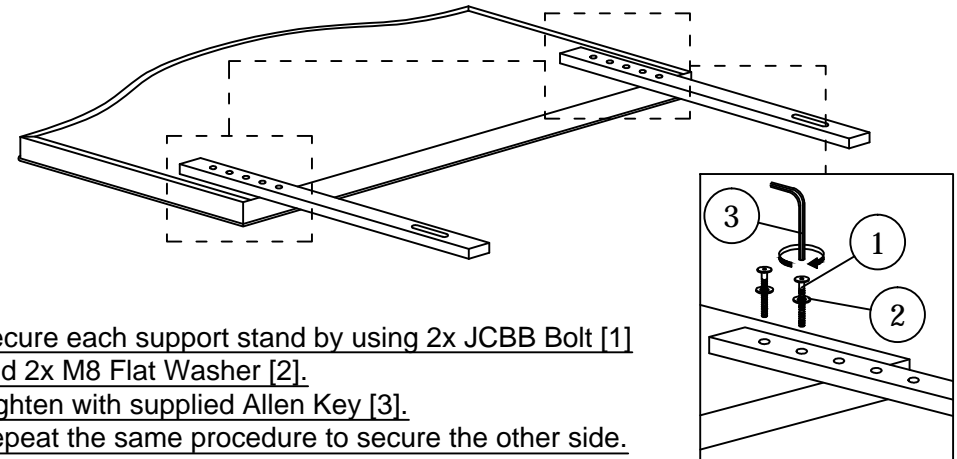

Secure each support stand by using 2x JCBB Bolt [1] and 2x M8 Flat Washer [2].
Tighten with supplied Allen Key [3].
Repeat the same procedure to secure the other side.

STEP 3

Your headboard assembly is complete.
Note: Hardware may loosen over time. Periodically check that all connections are tight.

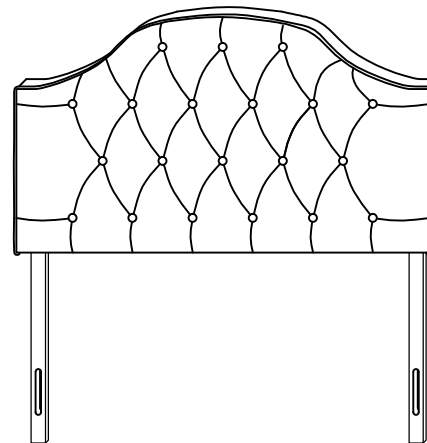

MODEL : BBT 6620 TWIN HB

ASSEMBLY INSTRUCTIONS (BED FRAME)

Read instructions carefully. See furniture and hardware part list on the right for guidance.







Have all parts ready before assembly. Place all wooden furniture parts on a clean and flat soft surface to prevent scratching.

Before you start, here are some words of caution:

1. Do not FULLY - TIGHTEN nuts and bolts until all nuts and bolts are partially tightened.
2. Do not FULLY - TIGHTEN nuts and bolts to avoid causing damage to the threading.
3. Keep all hardware parts out of reach of children.

NOTE : THE LIST AND QUANTITY SHOWN ARE FOR 1 UNIT ASSEMBLY.

FURNITURE PART LIST		
ITEM	DESCRIPTION	QTY
A	HEADBOARD	1 PC
B	BED FRAME	1 PC

HARDWARE PART LIST			
ITEM	DESCRIPTION		QTY
1	JCBB BOLT M6 x 60mm		4 PCS
2	JCBB BOLT M6 x 35mm		4 PCS
3	M6 FLAT WASHER		8 PCS
4	M6 SPRING WASHER		4 PCS
5	M6 HEX NUT		4 PCS
6	M4 ALLEN KEY (BALL SHAPE)		1 PC

STEP 1

Note: Extra screws were provided for attaching the headboard to your bed frame (use is optional).

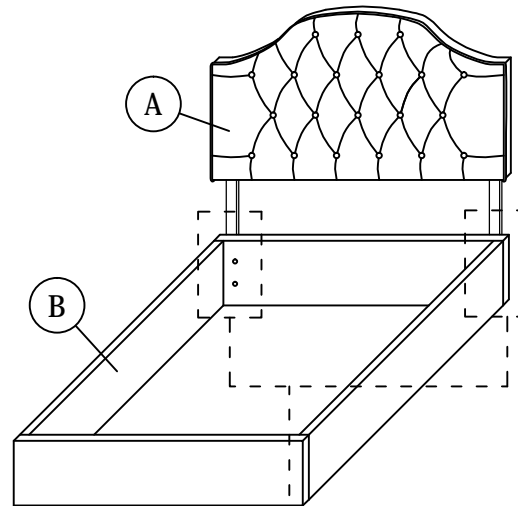

1. Line up the bed frame board's pre-drilled holes to match those of the headboard.

2. Secure the headboard to the bed frame by using 2x JCBB bolt 60mm (1) for the thicker bed frame, and 2x JCBB bolt 35mm (2) for the thinner bed frame. Before inserting each bolt, place a M6 spring washer (4) and M6 flat washer (3) on each bolt. Then fit a M6 flat washer (3) on the screw as it protrudes through the other side of the bed frame.

3. Place a M6 Hex Nut (5) after the M6 flat washer (3) at the end of each screw. Then tighten by using the M4 Allen key (6).

4) Repeat the same procedure for each screw and each side of the bed frame.

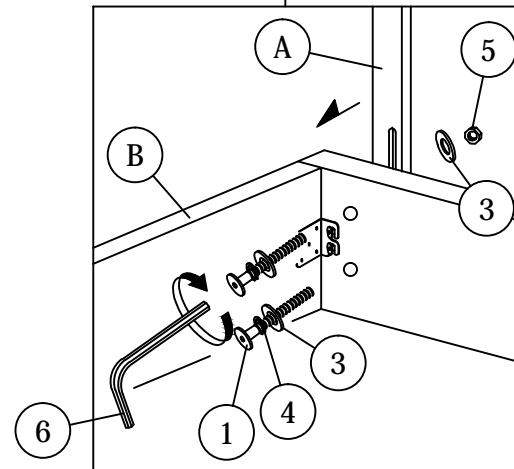

STEP 2

