

Read this instruction carefully. See hardware and furniture part list for guidance. Be sure all parts are complete, before you assemble. Place all wooden furniture parts on a clean and flat soft surface to prevent from being scratched. Follow the figure to start assembling.

CAUTIONS : 1. Do not FULLY - TIGHTEN the nut or nut bolt until all nut or bolt is ready assembled.
 2. Do not OVER - TIGHTEN the nut or bolt to avoid causing damages to the thread.
 3. Keep all hardware parts out of reach of children.

NOTE : THE LIST AND QUANTITY SHOWN ARE FOR 1 UNIT ASSEMBLY.
 Tool needed : Screwdriver (not provider).

PART LIST		
ITEM	DESCRIPTION	QTY
A	HEADBOARD	1 PC
B	FOOTBOARD	1 PC
C	SIDE RAIL	2 PCS
D	CENTER RAIL	1 PC
E	CENTER SUPPORT	2 PCS
F	CENTER SUPPORT LEG	3 PCS
G	BED SLAT	24 PCS
H	BED LEG	4 PCS

HARDWARE LIST		
ITEM	DESCRIPTION	QTY
1	JCBB BOLT M8 x 30mm	8 PCS
2	WOOD SCREW M3.5 x 16mm	8 PCS
3	BED SLAT SIDE FITTER	24 PCS
4	BED SLAT CENTER FITTER	12 PCS
5	M5 ALLEN KEY (BALL SHAPE)	1 PC
6	PVC BLACK WASHER	4 PCS

STEP 1

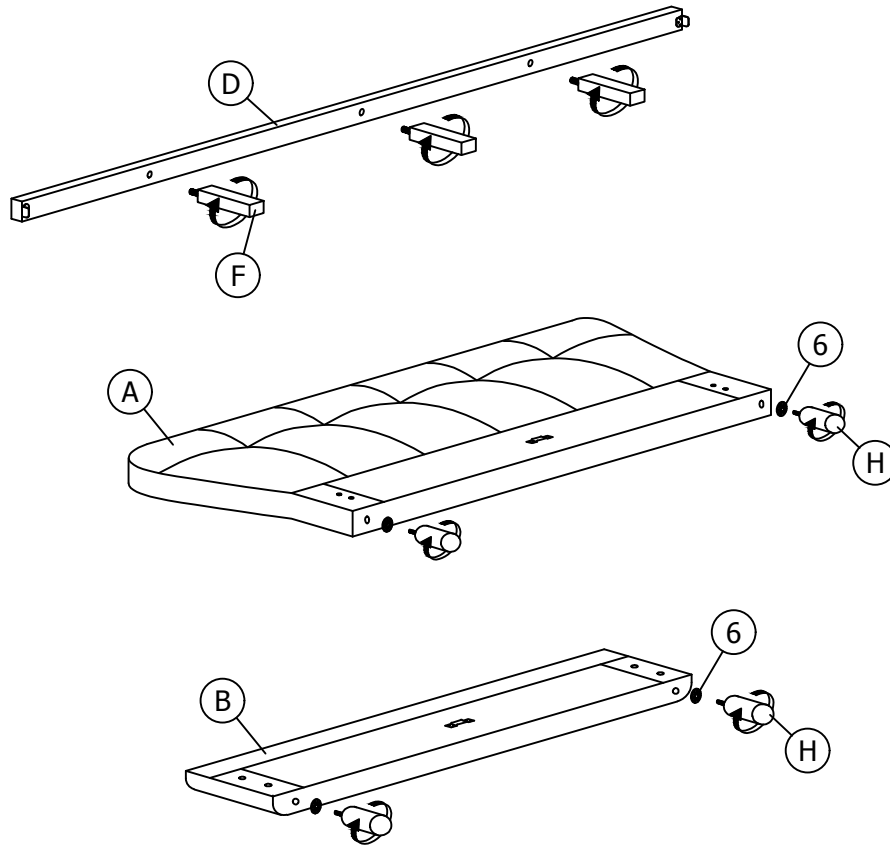

STEP 2

Loosely fit bolt (1) into Headboard (A) & Footboard (B) as picture shown.

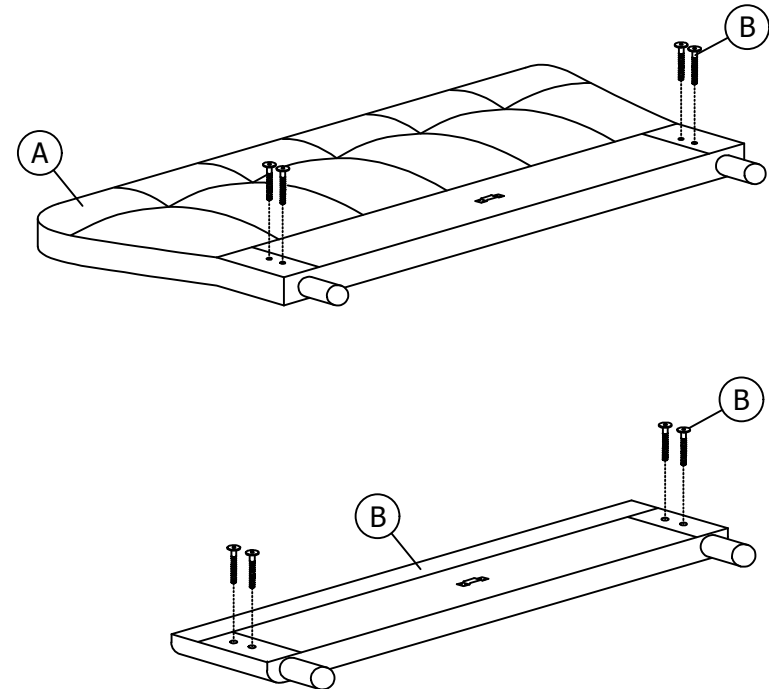

ASSEMBLY INSTRUCTIONS

STEP 3

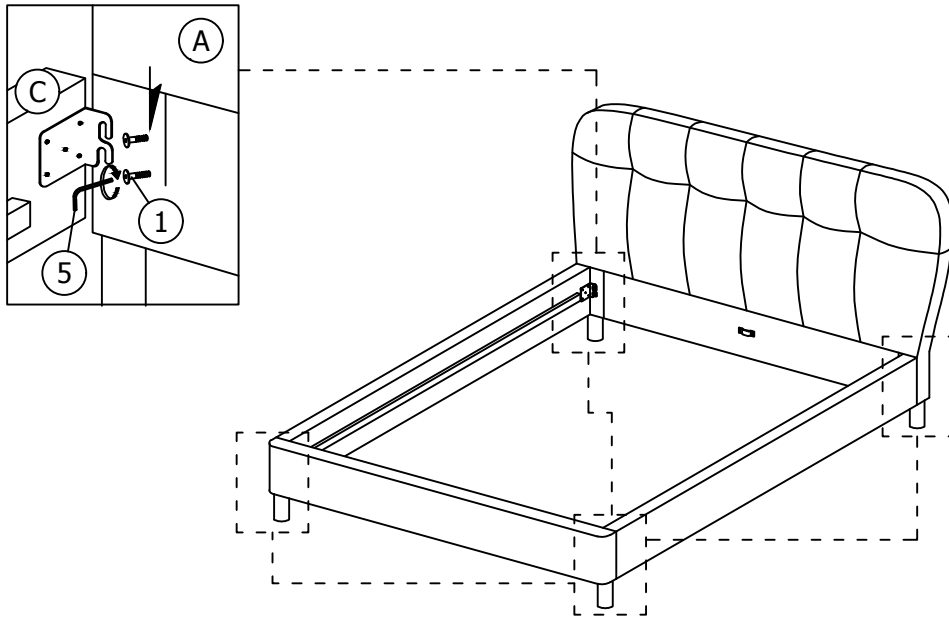

STEP 4

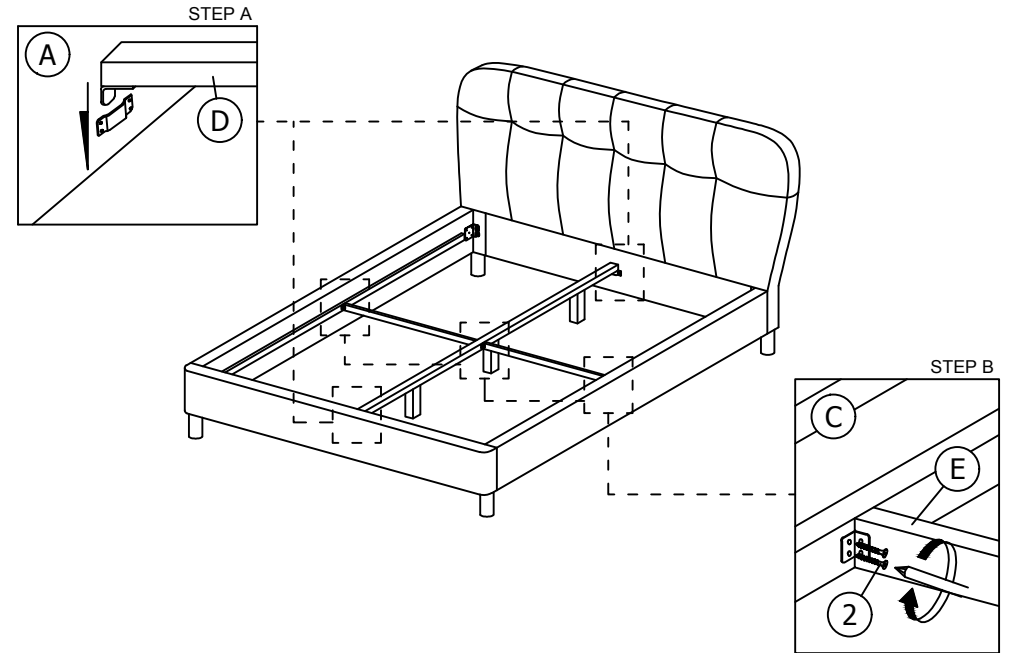

STEP 5

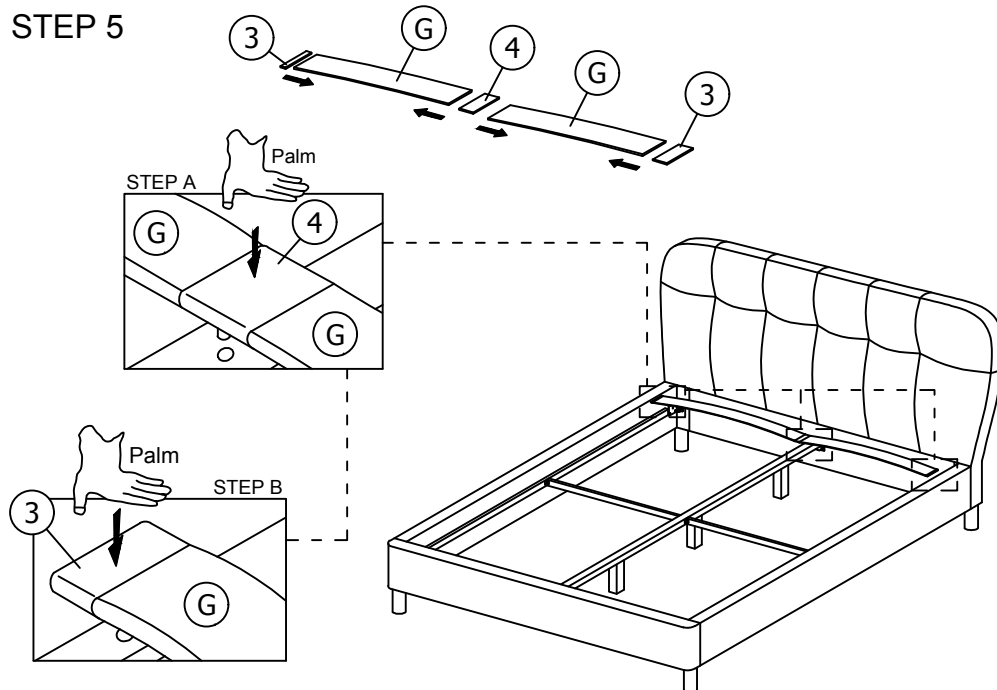

STEP 6

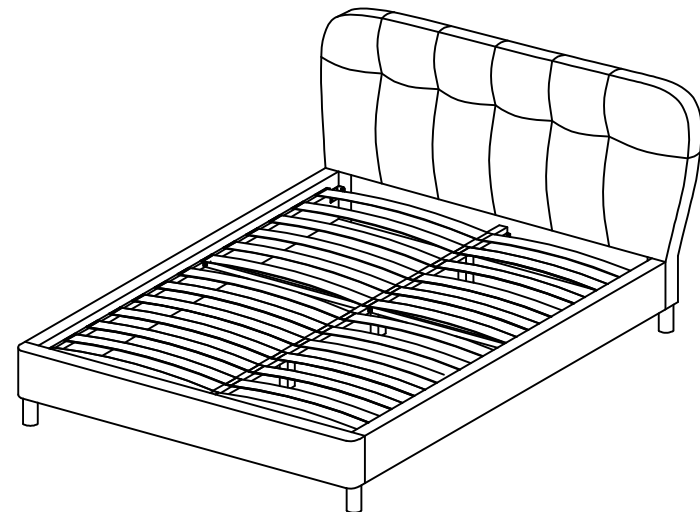

* When moving the bed position, the center support legs must be adjust to be straight to avoid any broken problem.