

Read this instruction carefully. See hardware and furniture part list for guidance. Be sure all parts are complete, before you assemble. Place all wooden furniture parts on a clean and flat soft surface to prevent from being scratched. Follow the figure to start assembling.

CAUTIONS : 1. Do not FULLY - TIGHTEN the nut or nut bolt until all nut or bolt is ready assembled.
2. Do not OVER - TIGHTEN the nut or bolt to avoid causing damages to the thread.
3. Keep all hardware parts out of reach of children.

NOTE : THE LIST AND QUANTITY SHOWN ARE FOR 1 UNIT ASSEMBLY.

PART LIST		
ITEM	DESCRIPTION	QTY
A	HEADBOARD	1 PC
B	HEADBOARD LEG (L&R)	2 PCS
C	FOOTBOARD	1 PC
D	SIDE RAIL	2 PCS
E	CENTER RAIL	1 PC
F	CENTER SUPPORT	2 PCS
G	CENTER SUPPORT LEG	3 PCS
H	BED SLAT	26 PCS
I	BED LEG	2 PCS
J	HEADBOARD SUPPORT WOOD	2 PCS
K	HEADBOARD SUPPORT RAIL	1 PC

PART LIST		
ITEM	DESCRIPTION	QTY
1	JCBB BOLT M8 x 30mm	8 PCS
2	JCBC BOLT M8 x 50mm	6 PCS
3	JCBC BOLT M8 x 60mm	4 PCS
4	JCBC BOLT M8 x 70mm	2 PCS
5	M8 FLAT WASHER	10 PCS
6	M8 SPRING WASHER	10 PCS
7	WOOD SCREW M3.5 x 16mm	8 PCS
8	BED SLAT SIDE FITTER	26 PCS
9	BED SLAT CENTER FITTER	13 PCS
10	M5 ALLEN KEY (BALL SHAPE)	1 PC

STEP 1

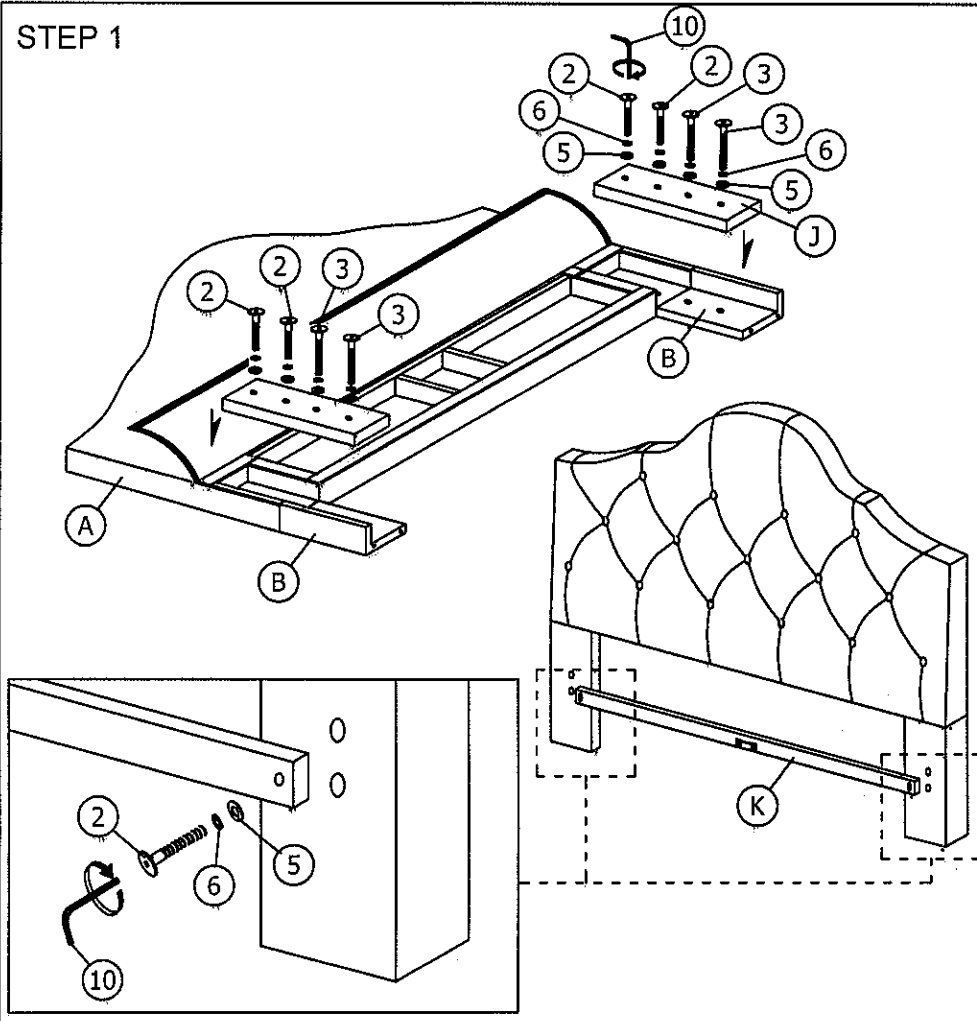

STEP 2

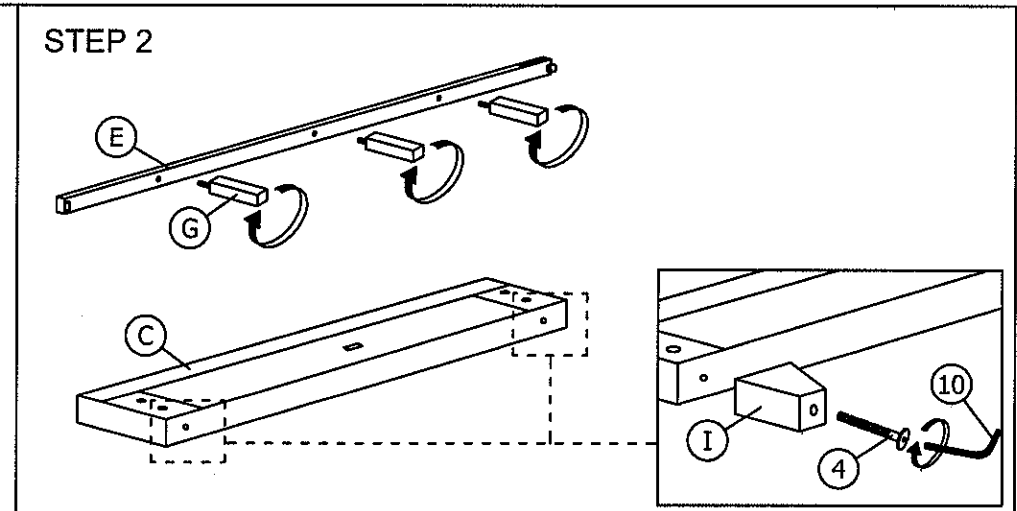

STEP 3

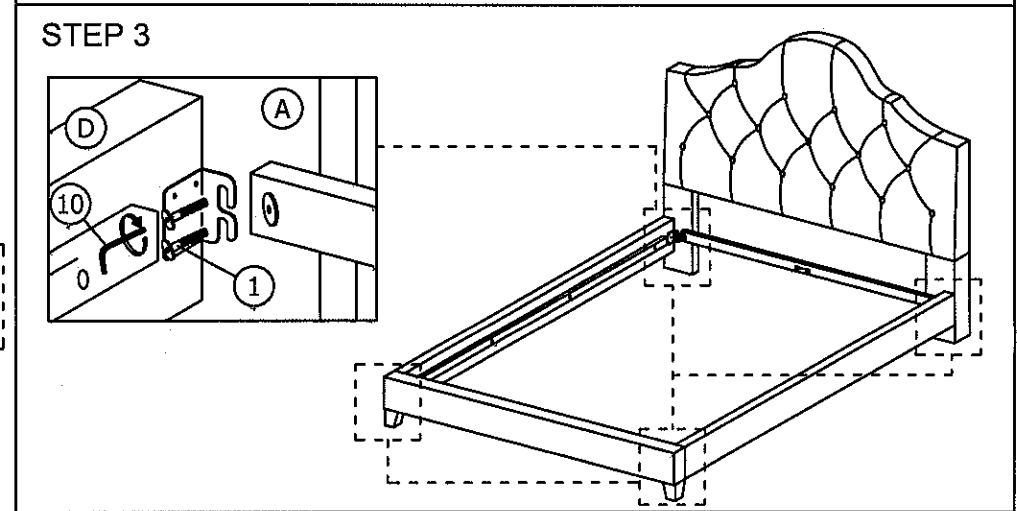

ASSEMBLY INSTRUCTIONS

STEP 4

Note: Make sure the sticker "-> HEADBOARD" faced to headboard [A]

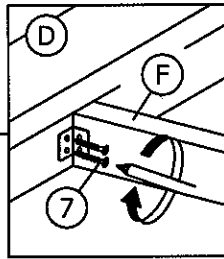
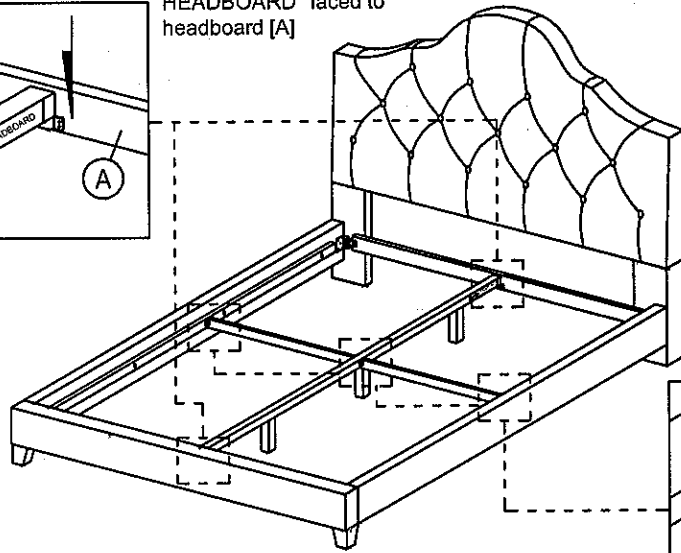
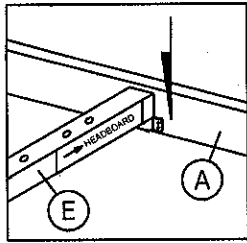

STEP 5

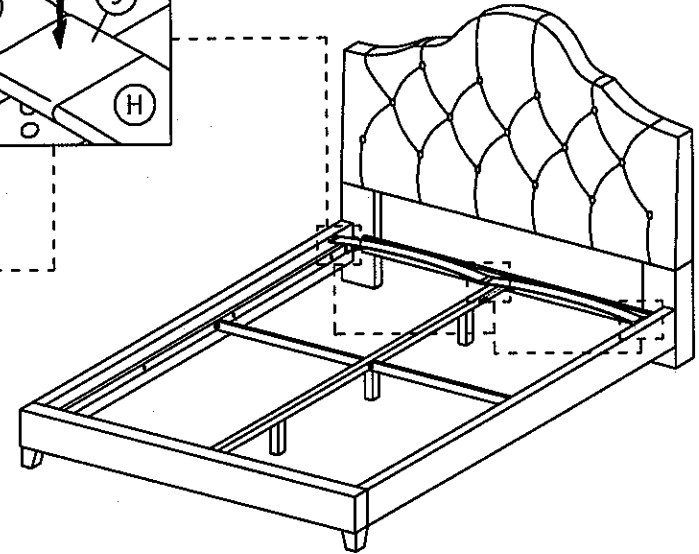
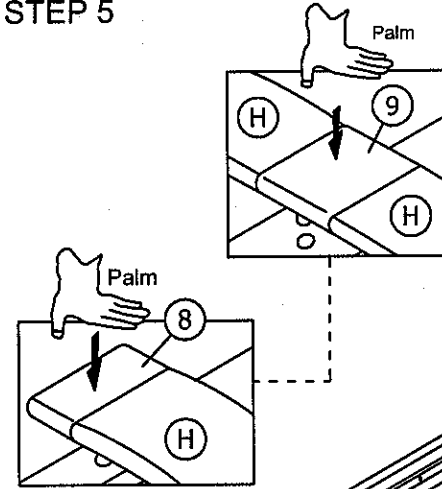

STEP 6

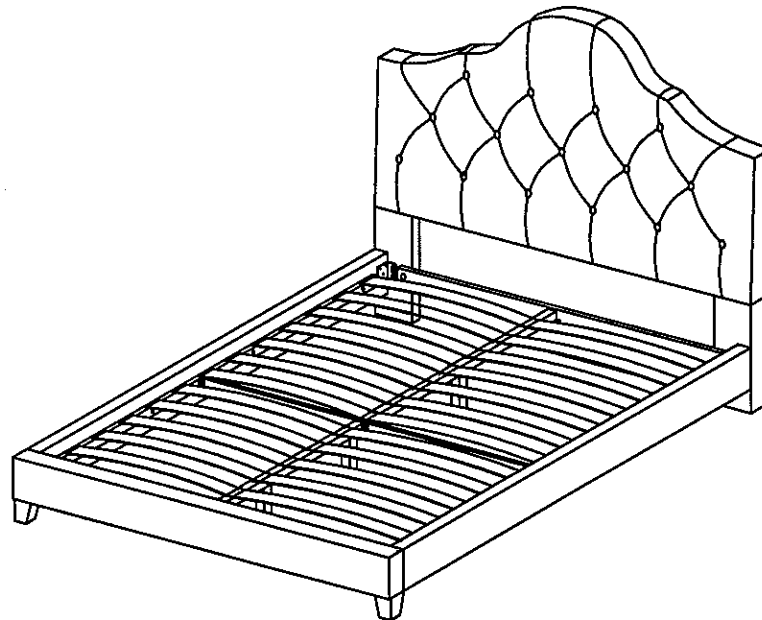

* When moving the bed position, the center support legs must be adjust to be straight to avoid any broken problem.