

Read this instruction carefully. See hardware and furniture part list for guidance. Be sure all parts are complete, before you assemble. Place all wooden furniture parts on a clean and flat soft surface to prevent from being scratched.







Follow the figure to start assembling.

- CAUTIONS :**
1. Do not FULLY - TIGHTEN the nut or nut bolt until all nut or bolt is ready assembled.
  2. Do not OVER - TIGHTEN the nut or bolt to avoid causing damages to the thread.
  3. Keep all hardware parts out of reach of children.

**NOTE :** THE LIST AND QUANTITY SHOWN ARE FOR 1 UNIT ASSEMBLY.

Tool needed : Screwdriver & Hammer (not provided).

PART LIST		
ITEM	DESCRIPTION	QTY
A	CUSHION	1 PC
B	LEG	2 PCS
C	SUPPORT RAIL	2 PCS
D	CENTER SUPPORT RAIL	1 PC

HARDWARE LIST		
ITEM	DESCRIPTION	QTY
1	JCBB BOLT M8 x 50mm 	4 PCS
2	M8 SPRING WASHER 	4 PCS
3	WOOD SCREW M4 x 32mm 	12 PCS
4	WOOD SCREW M4 x 45mm 	2 PCS
5	WOOD DOWEL M8 x 30mm 	8 PCS
6	M5 ALLEN KEY (BALL SHAPE) 	1 PC

## STEP 1

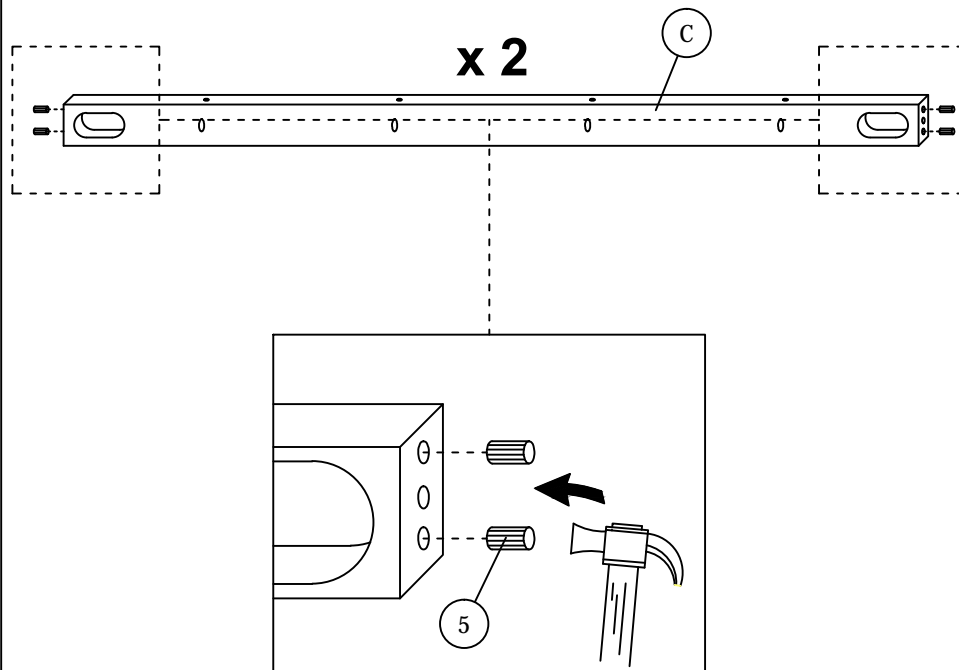

## STEP 2

