

MODEL : BBT 3137 STORAGE BOX

ASSEMBLY INSTRUCTIONS

Read this instruction carefully. See hardware and furniture part list for guidance. Be sure all parts are complete, before you assemble. Place all wooden furniture parts on a clean and flat soft surface to prevent from being scratched. Follow the figure to start assembling.

PART LIST		
ITEM	DESCRIPTION	QTY
A	STORAGE BOX	1 PC
B	LEGS	4 PCS

HARDWARE LIST		
ITEM	DESCRIPTION	QTY
1	-	-

- CAUTIONS :**
1. Do not FULLY - TIGHTEN the nut or nut bolt until all nut or bolt is ready assembled.
 2. Do not OVER - TIGHTEN the nut or bolt to avoid causing damages to the thread.
 3. Keep all hardware parts out of reach of children.

NOTE : THE LIST AND QUANTITY SHOWN ARE FOR 1 UNIT ASSEMBLY.

STEP 1

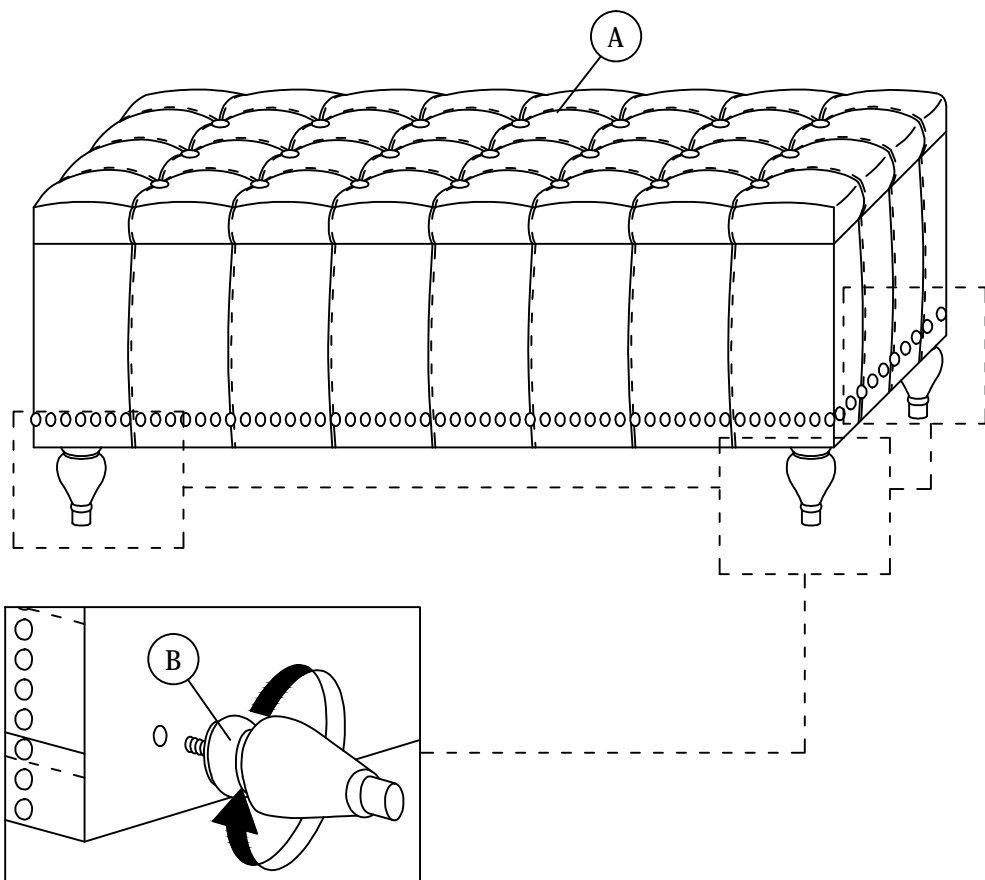

STEP 2

