

MODEL : BBT 3113 -3T

ASSEMBLY INSTRUCTIONS

Read this instruction carefully. See hardware and furniture part list for guidance. Be sure all parts are complete, before you assemble. Place all wooden furniture parts on a clean and flat soft surface to prevent from being scratched. Follow the figure to start assembling.

PART LIST		
ITEM	DESCRIPTION	QTY
A	CABINET	1 PC

PART LIST		
ITEM	DESCRIPTION	QTY
1	WOOD SCREW M4 x 32mm 	4 PCS
2	25mm SOFA LEG 	4 PCS

- CAUTIONS :**
1. Do not FULLY - TIGHTEN the nut or nut bolt until all nut or bolt is ready assembled.
 2. Do not OVER - TIGHTEN the nut or bolt to avoid causing damages to the thread.
 3. Keep all hardware parts out of reach of children.

NOTE : THE LIST AND QUANTITY SHOWN ARE FOR 1 UNIT ASSEMBLY.

STEP 1

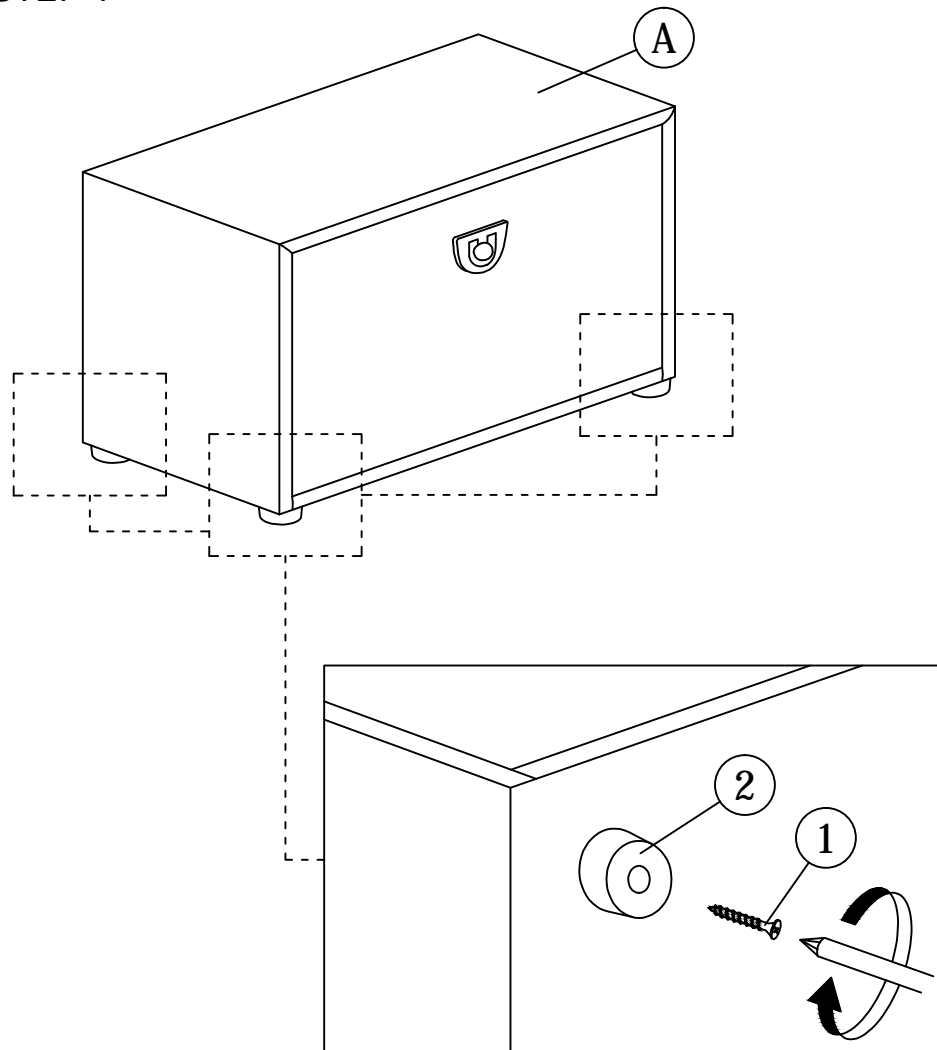

STEP 2

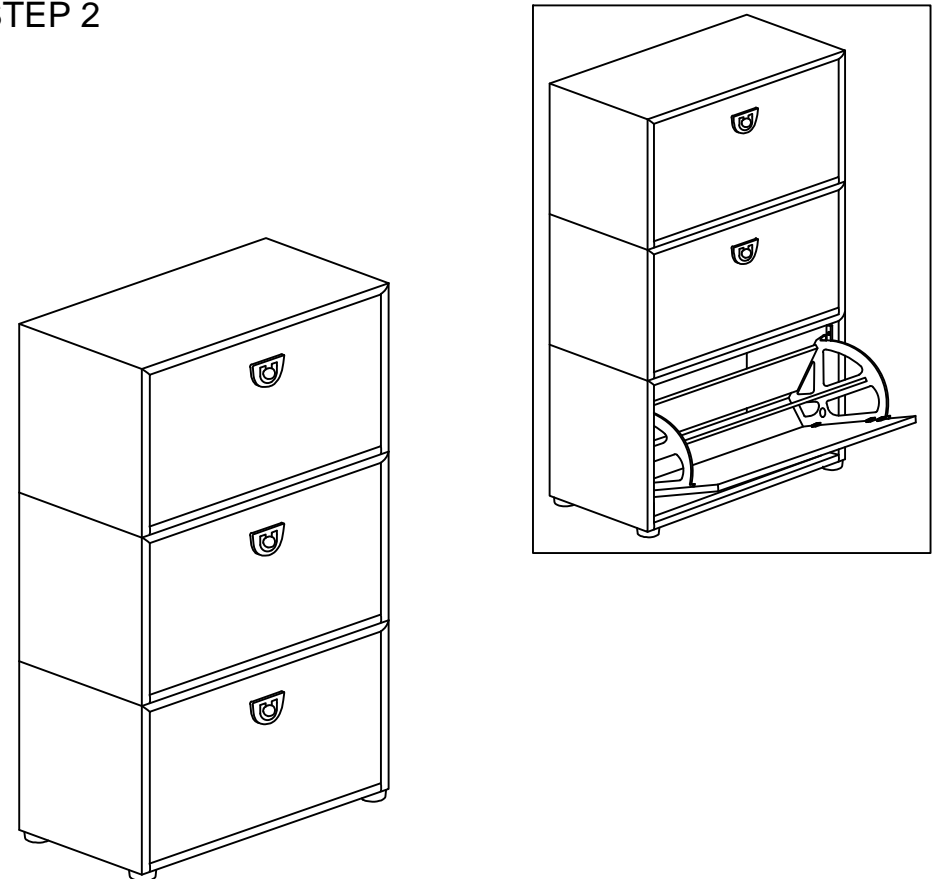

Note:

May choose straight placement as picture show, please remove upper cabinet's sofa legs (Item 2) before you place on top.